

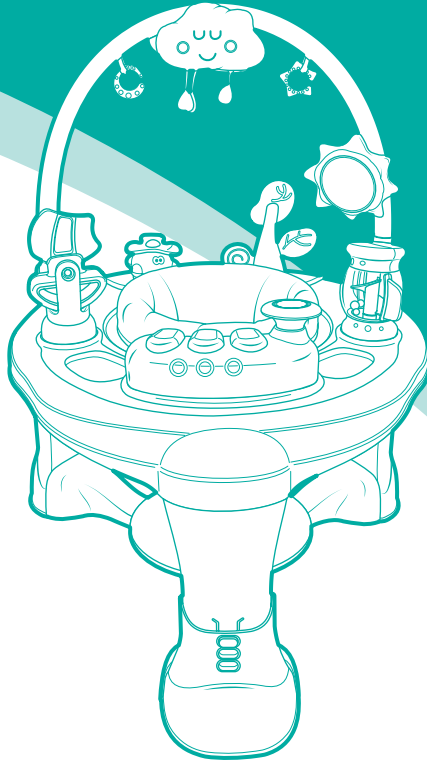

Lovely World Activity Centre

Instruction manual



INSTRUCTIONS: Read the instructions carefully before use and keep them for future reference. The child may be hurt if you do not follow these instructions.

Suitable for children who can sit up unaided, approximately from 4 months. It is not intended for children who can walk by themselves and weigh more than 11kg/25lbs.

Safety instructions

Warning: Adult assembly required.

Warning: Use the activity centre only if your child meets all of the following conditions:

- Your child is at least 4 months old.
- Your child can sit up unaided.
- Your child is less than 76.2cm (30 inch) tall.
- Your child weighs less than 11kg (25lbs).

Warning: DO NOT place children who can stand or walk on their own in the activity centre.

Warning: Do not use the activity centre in dangerous conditions or situations.

Warning: NEVER leave the child unattended in the activity centre. ALWAYS keep child in view while child is in the product.

Warning: NEVER move the activity centre while the child is in the seat.

Warning: It can be dangerous to allow other children to play near the activity centre.

Warning: Strings can cause strangulation! DO NOT place items with string around child's neck, such as hood strings or dummy cords. DO NOT suspend string over the product or attach strings to toys or place near curtain blinds cords or other hanging cords. Do not add any strings or straps to any part of the activity centre.

Warning: DO NOT use any parts other than those supplied or recommended by the manufacturer.

Warning: Only seat your child in the activity centre if the jump platform is attached.

Warning: DO NOT place the activity centre on an elevated surface or near steps or stairs. A child's movement can slide the activity centre.

Warning: To avoid the activity centre toppling over, place it on a flat, level floor. Adjust legs to same height so that the tray is level before placing child in the product.

Warning: For INDOOR use only.

Warning: Do not use the product if any of the toys, seat or structural parts are damaged.

Remove the child immediately if you find any small loose parts or sharp/broken parts.

Important: Care should be taken in unpacking and assembly.

Important: Examine product frequently for damaged, missing, or loose parts.

Battery warnings

- batteries should always be changed by an adult;
- follow the assembly instructions carefully and always take care to insert your batteries correctly, observing the plus and minus marks on the battery and appliance;
- non-rechargeable batteries are not to be recharged [never attempt to re-charge ordinary (non-rechargeable) batteries];
- rechargeable batteries are only to be charged under adult supervision;
- rechargeable batteries are to be removed from the toy before being charged;
- different types of batteries or new and used batteries are not to be mixed;
- batteries are to be inserted with the correct polarity;
- exhausted batteries are to be removed from the toy;
- the supply terminals are not to be short-circuited;
- keep batteries out of reach of children;
- always remove batteries if you are not going to use the product for long periods (as batteries may leak and cause damage);
- exhausted batteries should be removed from the product and disposed of in accordance with the makers recommendations;
- never dispose of batteries in a fire as this may cause them to explode;
- children can choke on batteries. If swallowed seek medical advise immediately.

Battery disposal

Exhausted batteries should be removed from the product and taken to a recycling facility. You can place batteries marked alkaline in normal household waste, but these are better taken to a recycling facility.

Please follow these symbols on batteries, which contain harmful substances:

Pb = Battery contains Lead

Cd = Battery contains Cadmium

Hg = Battery contains Mercury



Pb



Cd



Hg

Batteries should not be considered regular waste. Empty batteries should be returned to a recycling facility



Your 3 year warranty

Whilst we make and test our products to the highest standards of durability there's always a small chance of a hiccup! Our promise is to repair, replace or refund a MyChild product that has an identified manufacturing defect from the date of purchase for a full 3 years thereafter at no extra cost.

However, you must register within 28 days of the date of purchase to receive the full 3 years guarantee!

To receive your full guarantee you can register your product by: visiting <https://mychild.co.uk/pages/warranty> and complete the warranty form, or by telephone on 0161 335 2508.

Welcome

Thank you for purchasing the MyChild Lovely World Activity Centre. Please read the instructions and warnings carefully before use to ensure safe and satisfactory operation of this product.

Your child's safety is your responsibility. If you have a query with this product or require replacement parts, please contact the MyChild Helpline on 0161 335 2508.

Lay out the parts on a soft level surface and compare to the part/fixings checklist below. Do not discard any packaging until you are sure that you have all the parts.

WARNING! Assembly by an adult. Keep away from children until fully assembled. Keep children clear during assembly as pack contains small parts which may present a choking hazard.

Parts List

You will require one Phillips screwdriver (not supplied)



Contained in your carton are:

Nº	Part	Qty
1	Legs	3
2	Feet	3
3	Screws	6
4	Activity Centre Top	1
5	Removable Toy Mount	1
6	Seat Ring	1
7	Seat Fabric	1
8	Flying Car Toy	1
9	Tree Teether	1
10	Candy Jar Toy	1
11	Boat Toy	1
12	Musical Play Tray	1
13	Sun Mirror	1
14	Cloud	1
15	Teethers	2
16	Toy Bar End Mounts	2
17	Toy Bar	1
18	Stool	1
19	Footplate	1

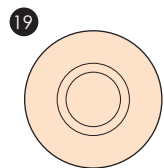
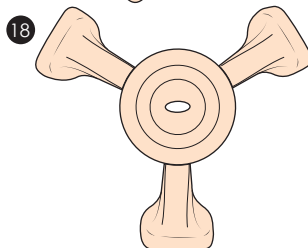
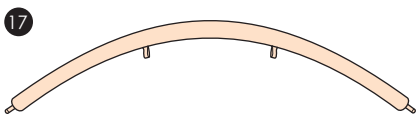
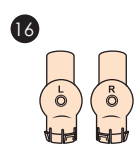
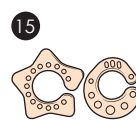
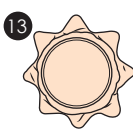
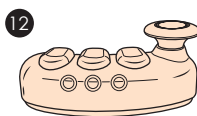
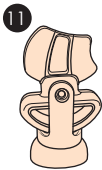
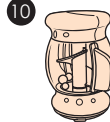
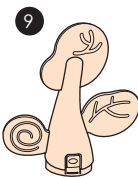
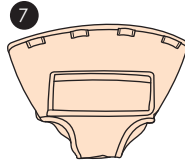
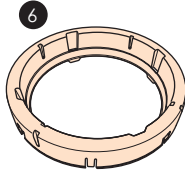
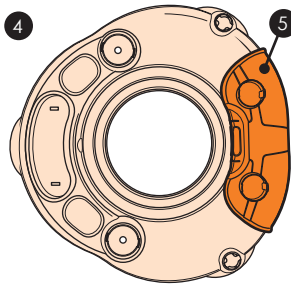
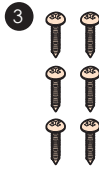
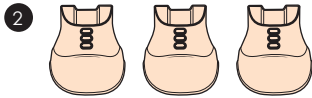
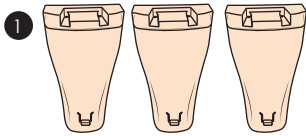

Attaching Legs and Feet

1. Place the Activity centre top (4) face-down on the floor and insert the three legs (1) into their fixing points. Secure all legs using screws (3). Ensure all screws are tightened correctly using a Phillips screwdriver (not supplied).

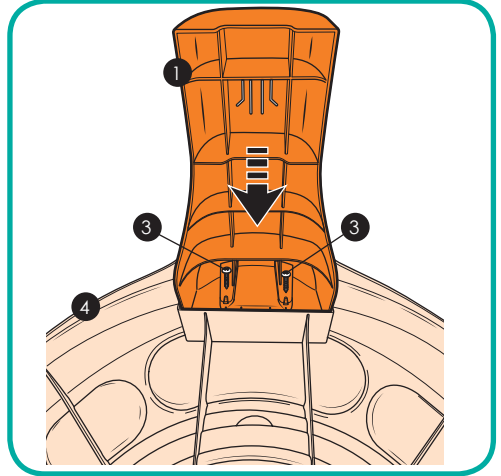

2. Press in button (A) on the leg and push the foot onto the leg ensuring the button 'clicks' into place. Repeat until all three legs are attached and are at the same height.

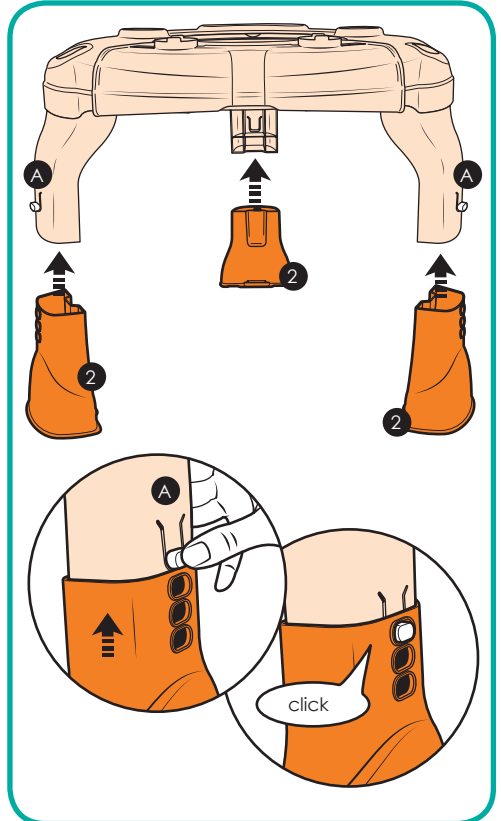

Assembling and attaching the jump platform

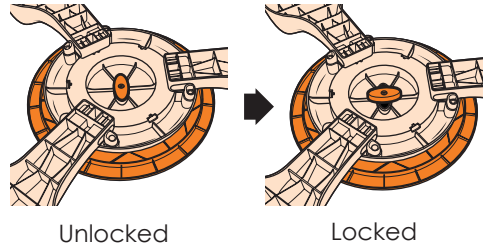
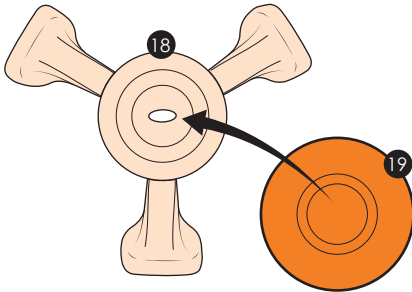

1. Ensure the stool (18) is folded down (see “Converting the stool” on page 11).

Attach the footplate (19) to the stool (18) and lock it in place

2. Place the jump platform under the activity centre and attach the three stool legs (i, ii, iii) to the feet of the activity centre.

WARNING! Children MUST NOT be seated in the activity centre unless the jump platform is attached.

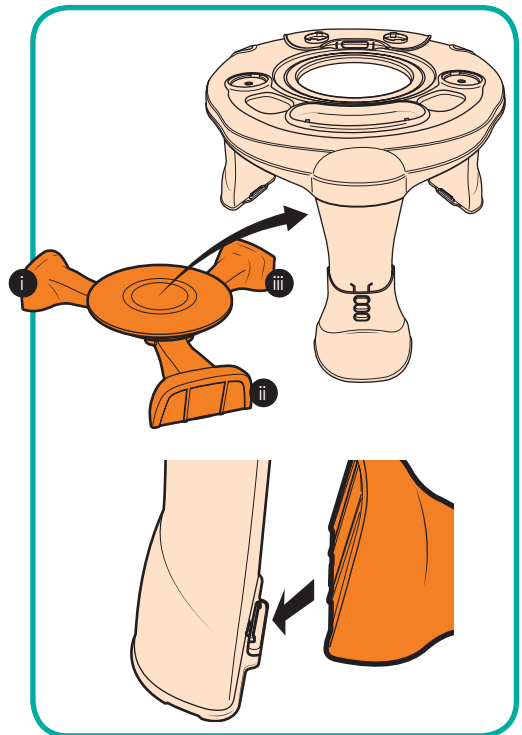

Seat assembly

WARNING! Children MUST NOT be seated in the activity centre unless the jump platform is attached.

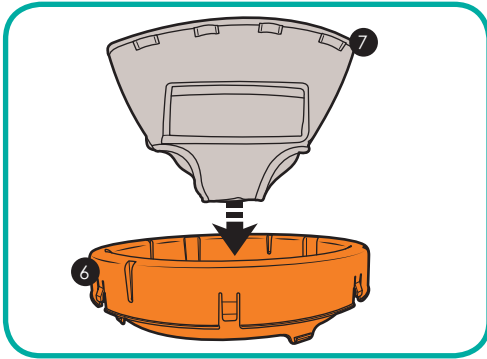

1. Place the seat fabric (7) into the seat unit (6).

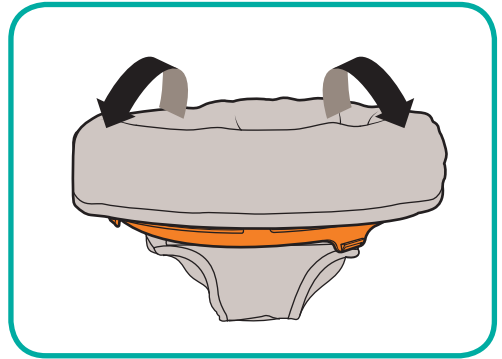

2. Fold the seat fabric over the seat unit.

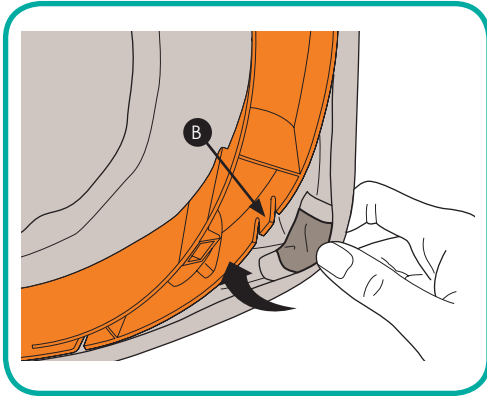

3. Hook the 8 webbing strips on the underside of the seat fabric over the tabs (B) on the seat unit.

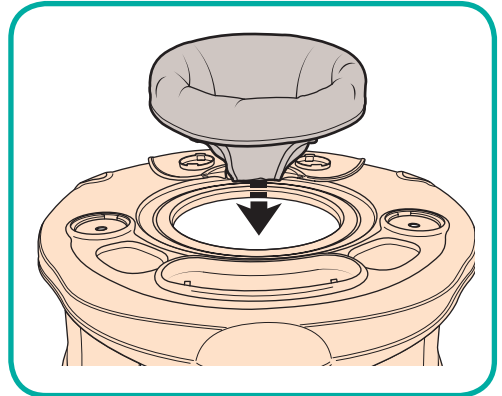

4. Insert the assembled seat unit into the seat tray, pressing it down until it 'clicks' into place.

5. Check the seat unit is able to rotate fully 360 degrees in both directions.

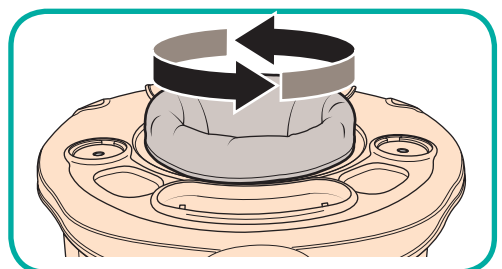

Toys assembly

1. Insert the Flying car toy (8) and Tree Teether (9) into the sockets located on the removable toy mount (5).

Note: Toys (8) and (9) can be put in either socket.

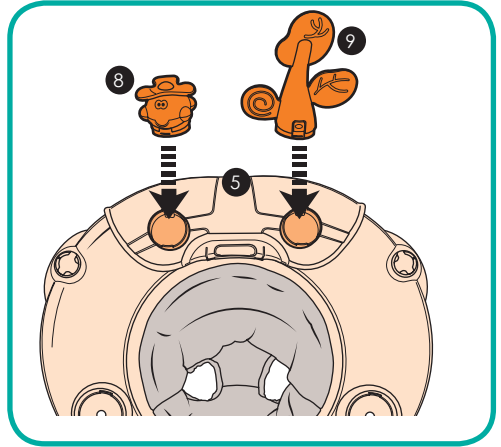

2. Insert the Candy jar toy (10) and Boat toy (11) into the sockets located on the activity centre top and turn the toys clockwise to lock them in position.

Note: Toys (10) and (11) can be put in either socket.

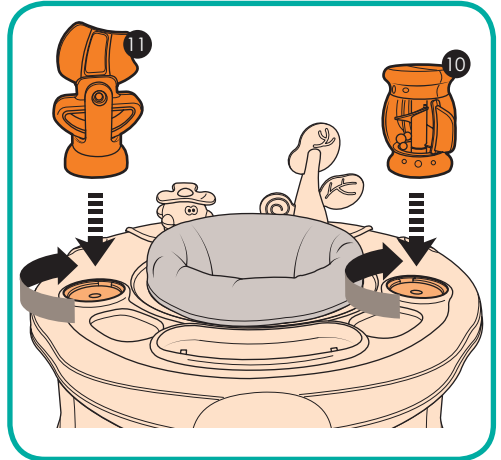

Musical play tray assembly

1. Using a Phillips screwdriver remove screw (A) from battery compartment on the underside of the musical play tray (12).

Open the battery compartment (B).

WARNING: Assembly by an adult.

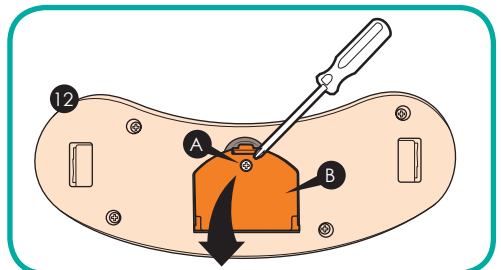

Musical toy assembly (continued)

2. Insert 2 x 1.5V AA batteries (not supplied) ensuring the correct battery orientation is observed and then reattach the cover, replacing the screw and ensuring it is not over tightened.

ATTENTION: Refer to 'Battery warnings' on page 2.

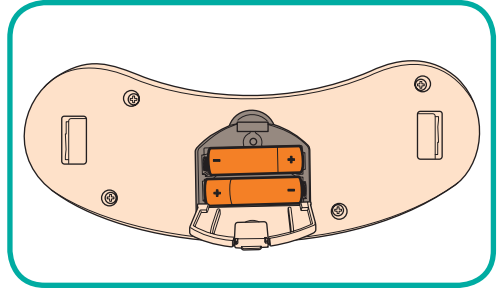

3. Insert the musical toy (12) into the large recess at the front of the activity centre.

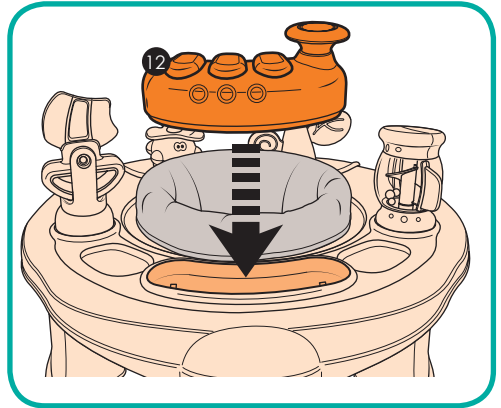

4. With the musical play tray seated in the recess, locate the white plastic tabs on the underside of the large recess.

Push the two plastic tabs up and rotate clockwise to lock the musical play tray in place.

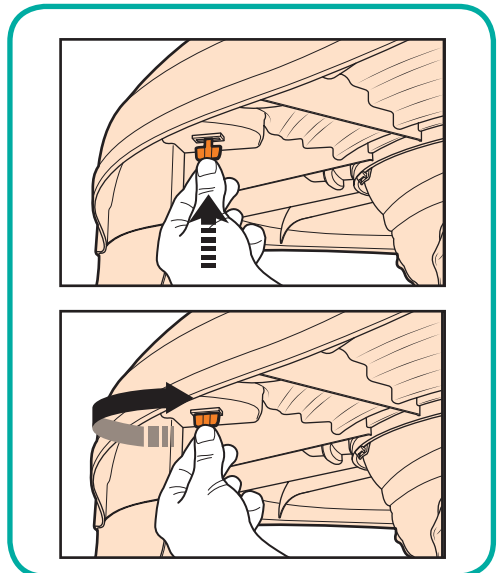

Toy bar assembly

IMPORTANT! Take care when attaching the Left and Right toy bar end mounts. The Toy Bar will not work correctly if the end mounts are incorrectly attached.

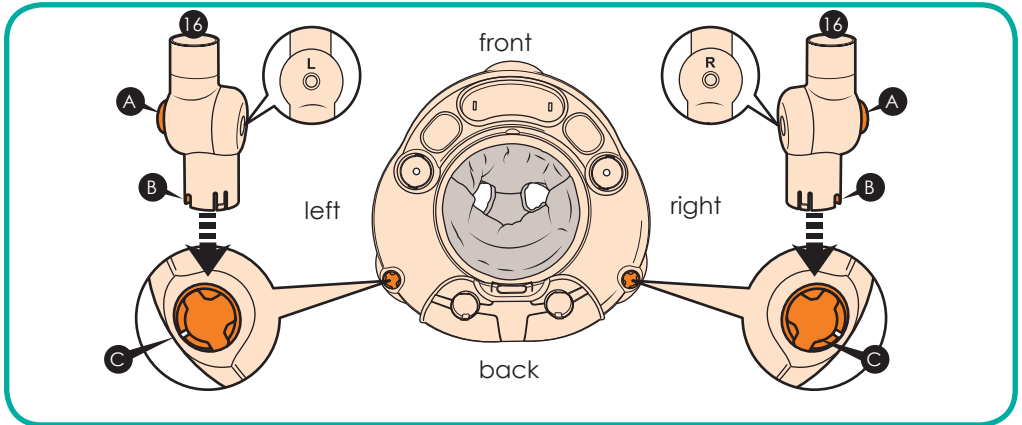

1. Insert the end mount (16) marked "L" into the mounting hole on the left hand side of the activity centre ensuring button (A) is facing outwards away from the activity centre and that locator slot (B) matches up with the locator tab (C) on the activity centre.

Insert the end mount (16) marked "R" into the mounting hole on the right hand side of the activity centre ensuring button (A) is facing outwards away from the activity centre and that locator slot (B) matches up with the locator tab (C) on the activity centre.

2. Insert both ends of the toy bar (17) into the two end mounts (16).

WARNING! NEVER use the toy bar to lift or carry the activity centre.

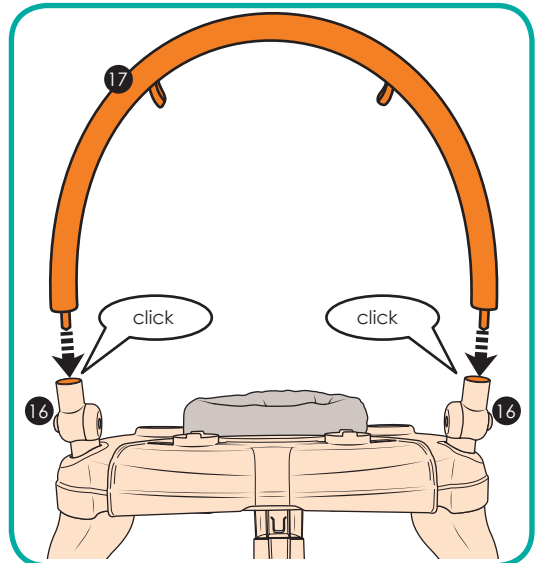

Toy bar assembly (continued)

3. Attach the sun mirror (13) and cloud (14) in your desired location on the toy bar using the velcro tabs and hook the teethers (15) through the loops on the toy bar.

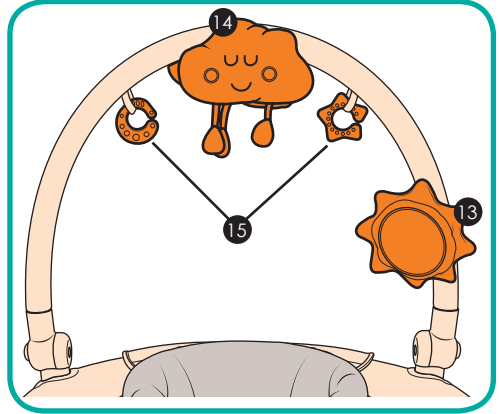

Converting the stool

To convert from the jump board mode to a stool:

1. Unlock and remove the jump platform (19).

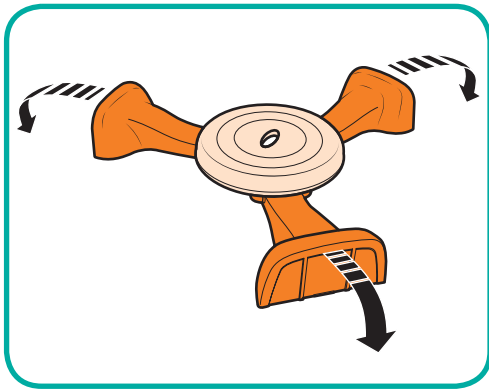
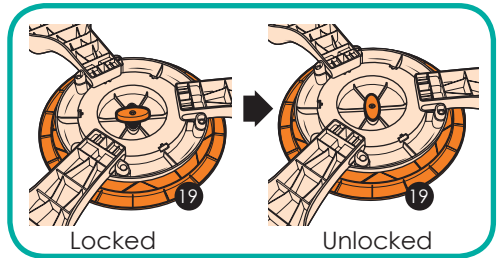

2. Pull the stool legs outwards and rotate them downwards.

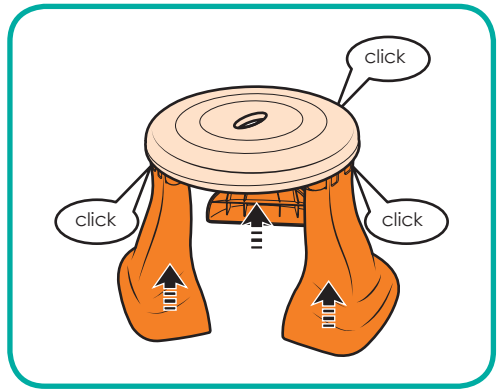

3. Push all three legs upwards till they "click" and lock into place.

To convert from a stool to jump board mode: Reverse the above steps.

Converting the seat into a storage basket

1. Remove the seat unit from the activity centre by pressing the four clips (A) on the underside of the seat unit whilst lifting and rotating the seat unit.

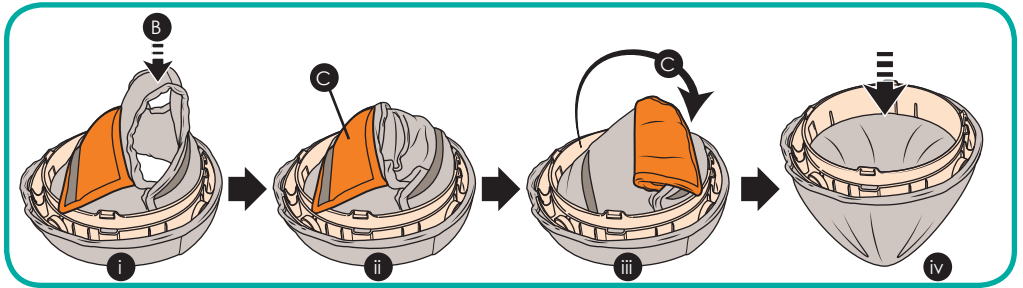
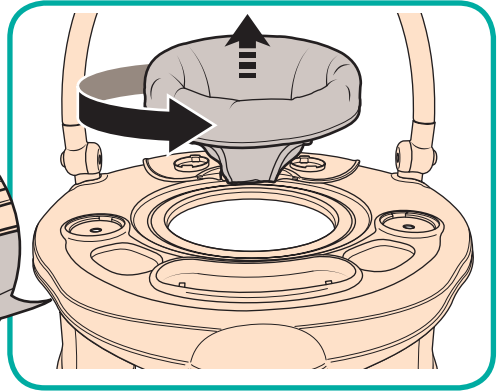
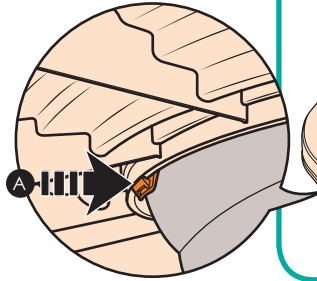

2. With the seat upside down;

- i. Push the crotch part of the fabric with leg holes (B) down out of the way.
- ii. Release flap (C) from it's velcro tab.
- iii. Fold flap (C) over to cover the leg holes and attach the flap to velcro tab.
- iv. Push the seat fabric down through the ring to form a basket.

3. Attach the basket into the activity centre from below ensuring all four clips "click" into position.

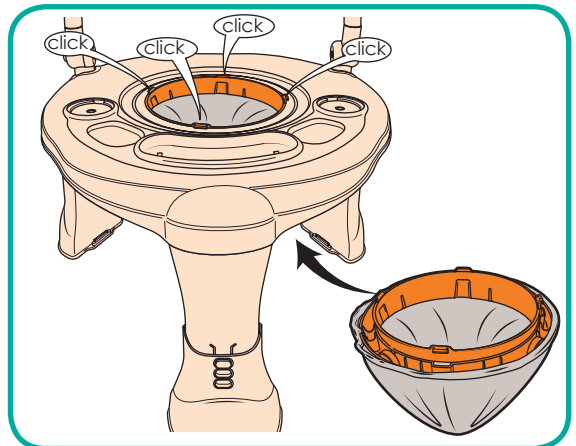

Converting activity centre to a play table

1. Remove all the plastic toys from the activity centre top.

Unclip the flying car toy (8), tree teether (9) and remove.

Turn the boat toy (11) and candy jar toy (10) anti-clockwise to unlock them and remove.

Release the plastic tabs on the underside of the activity centre holding the musical play tray (12) in place and remove.

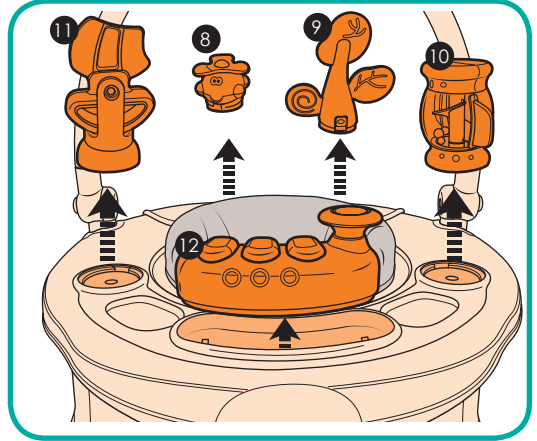

2. Fold the toy bar down by pressing and holding in both buttons (A) and at the same time rotate the toy bar downwards.

Note: The toys on the toy bar can be left in place or removed if you wish.

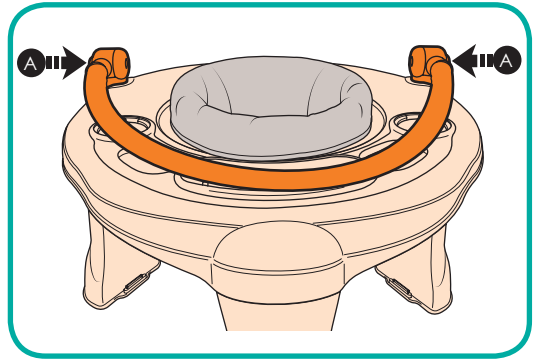

3. Remove the seat unit from the seat tray by pressing the four clips (A) on the underside of the seat unit whilst lifting and rotating the seat unit.

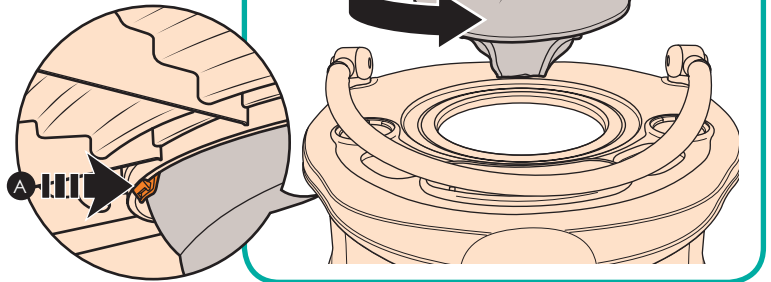

Converting activity centre to a play table (continued)

4. Squeeze the release clip on the top of the removable toy mount and pull the mount up by approx 1 cm.

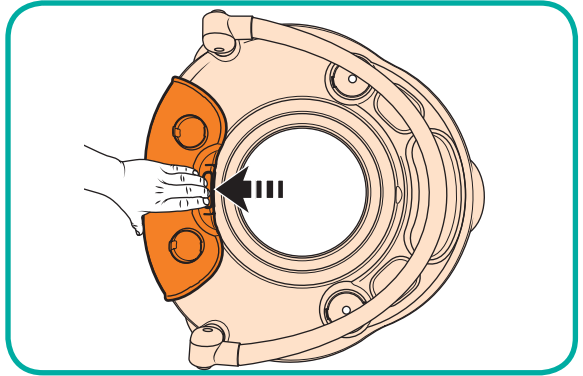

5. Squeeze the release clip on the underside of the removable toy mount and remove the toy mount.

If the toy mount will not remove check that the first clip is fully released.

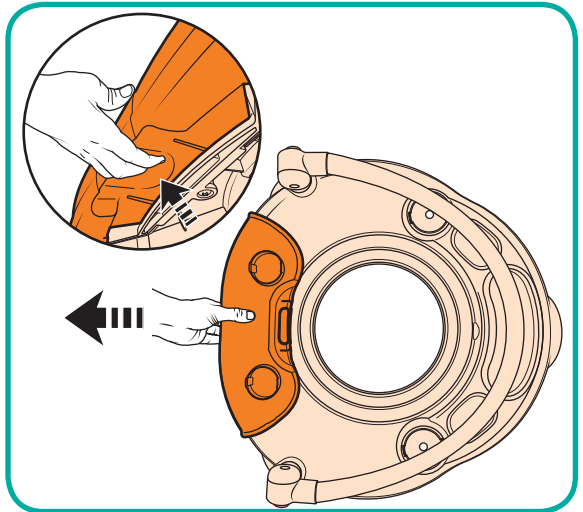

6. Finally place the footplate (19) into the centre of the activity centre to form the table top.

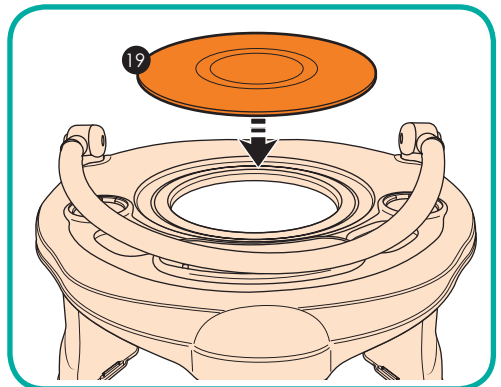

Height adjustment

1. Press in the button on each leg and raise or lower the leg until it clicks into place.

Note: Ensure all legs are set at the same height before using.

WARNING: DO NOT adjust the height whilst a child is seated in the activity centre.

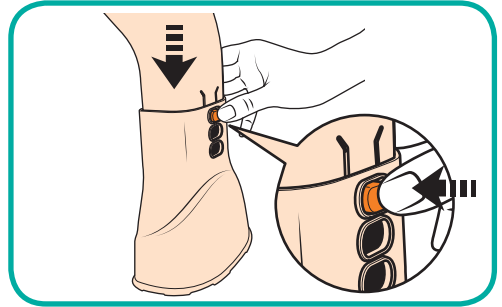

WARNING: If your child is too small or too big to stand with their legs straight and feet flat on the jump platform, then this product is no longer suitable for your child and your child should not use it. If your child is not standing correctly then this could lead to posture problems/discomfort or create a potential tipping hazard.

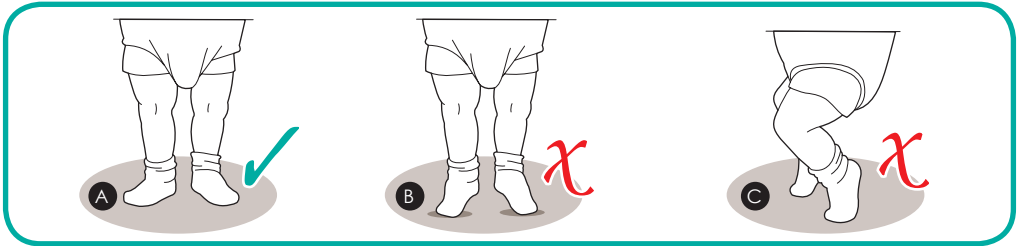

- A. Activity centre at correct height.
B. Activity centre too high (child is on tip-toes).
C. Activity centre too low (child has bent knees).

Care and maintenance

- To prolong the life of your nursery product keep it clean and do not leave it in direct sunlight for extended periods of time.
- Plastic parts can be wiped clean with a damp cloth and mild soap then allowed to air dry.
- DO NOT immerse plastic parts in water.
- Clean toys before use. NOT dishwasher safe.
- Removable fabric covers and trims may be machine washed in cold water on a delicate cycle. Use a low heat for tumble drying.
- Do not dry clean, or use bleach.
- Non removable fabric covers and trims may be cleaned using a damp sponge with soap or mild detergent. Allow it to dry completely before folding or storing it away.
- In some climates the covers and trims may be affected by mould and mildew. To help prevent this occurring, do not fold or store the product if it is damp or wet. Always store the product in a well ventilated area.
- Always check parts regularly for tightness of screws, nuts and other fasteners - tighten if required. To maintain the safety of your nursery product, seek prompt repairs for bent, torn, worn or broken parts.
- Regularly clean parts that have been mouthed by your child.



www.mychild.co.uk

Customerservice@kooltrade.co.uk
Imported by Kooltrade Ltd. M34 3QA
Tel: 0161 335 2508