



40-87cm  
max. 13kg

## Vamos Infant Carrier Instruction manual



**IMPORTANT:** READ CAREFULLY AND KEEP FOR FUTURE REFERENCE. Your child's safety may be affected if you do not follow these instructions.

For children from 40-87cm, up to a maximum weight of 13kg

This product conforms to ECE R129

This product is tested to EN1888-1:2018+A1:2022

## Safety advice

**WARNING:** The correct fitting of the vehicle seatbelt (following the guide markings) is of vital importance for the safety of your child. See the labels on the seat itself.

**WARNING:** Keep these instructions with the child car seat for future reference.

**WARNING:** Never leave your child unattended.

**WARNING: NEVER** use the child car seat on a passenger seat that is fitted with a front airbag. **THIS CAN BE VERY DANGEROUS.**

- The product is only safe if it is used in strict accordance with these instructions.
- The product must be replaced if it is involved in an accident as it may have unseen damage.
- Do not use this product second hand as you do not know its history.
- Ensure that all other passengers, luggage and loose objects are properly secured.
- Do not lubricate any of the moving parts.
- Never use the child car seat without the covers.
- Only covers approved by the manufacturer may be used. The covers are an integral part of the child car seat and it's safety performance.
- Ensure that the child car seat is not damaged by heavy objects or being caught in the car door.
- The rigid parts and the plastic sections of the child car seat should be positioned and installed in such a way that they cannot, under normal use of the vehicle, become trapped by a moving seat or in the vehicle door.
- Never make unauthorised alterations or additions to the product, such changes can be highly dangerous.
- Child car seat parts may become hot in direct sunlight. Cover with sheet to prevent this.
- Most accidents occur on short trips, so do not be tempted to avoid using the child car seat simply because you are not travelling very far.
- Do not leave the child in the child car seat for long periods of time. Take regular breaks on long journeys.
- Set a good example by always wearing a seatbelt yourself.
- Make sure that your child never plays with the buckle.

**WARNING:** Failure to follow each of the following instructions can result in your child striking the vehicle's interior during a sudden stop or crash.

**WARNING:** Take care that the straps holding the child car seat to the vehicle, are as tight as possible. Make sure that the straps restraining the child are adjusted to the child's body and the straps are not twisted.

**WARNING:** The child restraint system **MUST BE CHANGED** after it has suffered from a violent impact in an accident.



### **! Extreme Danger !**

**Do not use a rear facing child car seat on a passenger seat where an active passenger airbag is fitted. The airbag inflates rapidly and can throw a rear-facing child car seat into the back of a passenger seat with great force, which can injure or kill a child.**

## Vehicle seat travelling advice

In order to maximise the protection that the child car seat can give your child, please adjust the harness so that it fits snugly and make sure that the child car seat is fitted correctly.

Research shows that correct installation is the most important factor in child car seat safety.

Please take the time to read the instruction manual carefully.

This product offers maximum protection when it is used in accordance with the instructions.

If you have any questions concerning the use of the product please do not hesitate to contact us.

- This child car seat is designed for use for children whose weight is 13kg or less and whose length/height is between 40 to 87cm.
- This child car seat must only be used in a rear facing position, and must **NEVER** be used forward facing. For maximum protection, the centre rear seat position (if it is fitted with an adult 3-point seatbelt) is recommended as the safest position in most vehicles for installing an child car seat. (Only use the vehicle's rear centre seat if the vehicle seat is fitted with a 3-point adult belt).
- Do not use your child car seat on a vehicle seat with lap belts only.
- Your child car seat should not be purchased or sold as a second hand item.
- Remove child out of the car as first priority in an accident.
- While travelling it is recommended that any luggage or other objects liable to cause injuries in the event of a collision shall be properly secured.
- Your child car seat should be securely belted to the vehicle, even when unoccupied because in a crash an unsecured child car seat may injure other passengers.
- Please take a rest every two hours if you are travelling with a baby in the child car seat.
- Please check the child car seat condition if you are going to travel a long distance with a child.
- Please put all excess luggage into the boot of your car if you are going to travel with a baby, because loose items may hurt a baby when travelling on unstable roads or because they move suddenly when braking.
- Please always check the child car seat before you place a baby into it.
- Please get in touch with the dealer if anything breaks on the child car seat. Only the manufacturer or an authorised agent may do repairs. **DO NOT** try and fix the child car seat by yourself. It might be damaged or cause more damage.
- Always check the buckle hole before you buckle up as it may contain crumbs or obstructions that prevent a secure lock.
- Keep your child car seat out of reach of children when not in use.
- Please keep the plastic packaging bag out of the reach of children when unpacking the child car seat.
- **NEVER** place the child car seat on a seat where an airbag is active.
- Do not modify the child car seat.

## Vehicle seatbelt

The product must only be used with a 3-point vehicle seatbelt that has been approved to ECE 16 or equivalent. **NEVER** use a 2-point seatbelt. Your child car seat can be fitted in most cars. However, some vehicles are designed in such a way that proper installation may not be possible. In this case, try another vehicle seat.

## Notices

1. The child car seat must only be used in vehicles which are fitted with a three point seatbelt system that has been approved by regulation ECE-16 or similar.
2. This is Universal Belted Enhanced Child Restraint System. It is approved according to UN Regulation [No. 129], for use primarily in "Universal seating positions" as indicated by vehicle manufacturers in the vehicle user's manual.
3. If in doubt, consult either the Enhanced Child Restraint System manufacturer or the retailer.

## Safety when car seat attached to Vamos chassis

1. **WARNING:** Never leave your child unattended.
  2. **WARNING:** Ensure that all the locking devices are engaged before use.
  3. **WARNING:** To avoid injury ensure that your child is kept away when unfolding and folding this product.
  4. **WARNING:** Do not let your child play with this product.
  5. **WARNING:** Check that the pram body, pushchair body or seat unit attachment devices are correctly engaged before use.
  6. **WARNING:** This product is not suitable for running or skating.
- 
7. **WARNING:** This product is suitable for children whose weight is 13kg or less and whose length/height is between 40 to 87cm.
  8. **WARNING:** Always use the restraint system.
  9. **WARNING:** Parcels, accessories and other items (e.g. hand bags, shopping bags, etc) that are placed on the handles, back of the backrest or sides of the pushchair will affect the stability of the pushchair.
  10. **WARNING:** Always use the most reclined position for new born babies.
  11. **WARNING:** Do not lift and carry the pushchair with a child in it.
  12. **WARNING:** Do not use pushchair on steep slopes, stairs, escalators, beaches, mud, etc.
  13. **WARNING:** Do not allow your child to climb unassisted into or out of the pushchair.

## Safety advice for Vamos Chassis & car seat (continued)

14. **WARNING:** Ensure that children are clear of moving parts before making adjustments.
15. **WARNING:** Never leave raincovers, hoods and aprons on indoors or in hot weather as your child might overheat.
16. **WARNING:** Do not use replacement parts or accessories other than those approved by the manufacturer as others may render the product unsafe.
17. **WARNING:** Do not load the basket with a weight in excess of 2kg.
18. **WARNING:** Always apply the brakes when the pushchair is stationary, and when placing and removing children.
19. **WARNING:** Taking children up or down stairs, escalators, steps, steep slopes and muddy/rough terrain could be dangerous and should not be attempted. Remove your child from the pushchair for easy carrying to negotiate such hazards, or simply avoid them.
20. **WARNING:** Never assume a driver can see you or your child.
21. **WARNING:** If your pushchair is to be used by someone who is unfamiliar with it, e.g. grandparents, then show them how it works before letting them use it.
22. **WARNING:** Hold onto your pushchair when close to moving vehicles and trains as the draught from the vehicles may move the pushchair even with the brakes on.
23. **WARNING:** This product is designed to carry only one child at a time.
24. **WARNING:** This product is not intended for prolonged periods of sleeping.

This product complies with EN1888-1:2018+A1:2022

## Welcome

Thank you for purchasing the Vamos Infant Carrier.  
Please read the instructions and warnings carefully before use to ensure safe and satisfactory operation of this product.

Your child's safety is your responsibility. If you have a query with this product or require replacement parts, please contact your nearest MyChild retailer.

## Your 3 year warranty

Whilst we make and test our products to the highest standards of durability there's always a small chance of a hiccup! Our promise is to repair, replace or refund a MyChild product that has an identified manufacturing defect from the date of purchase for a full 3 years thereafter at no extra cost.

However, you must register within 28 days of the date of purchase to receive the full 3 years guarantee!

To receive your full guarantee you can register your product by:  
visiting [www.mychild.co.uk/warranty.html](http://www.mychild.co.uk/warranty.html) and complete the warranty form,  
or by telephone on 0161 335 2508.

# Parts checklist

- 1 Carry handle
- 2 Headrest
- 3 Shoulder pads
- 4 Harness buckle
- 5 Insert cushion
- 6 Harness adjuster button (under seat cover)
- 7 Harness adjuster strap
- 8 Button to remove adapters (under edge of seat cover)
- 9 Crotch pad
- 10 Instruction manual storage (under seat cover)

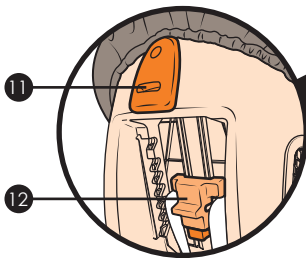
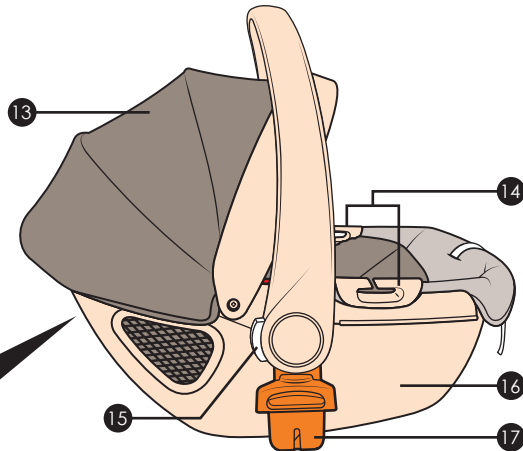
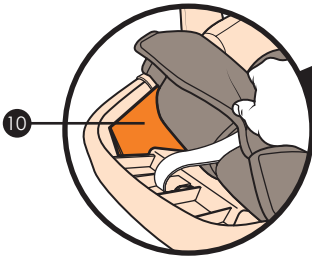
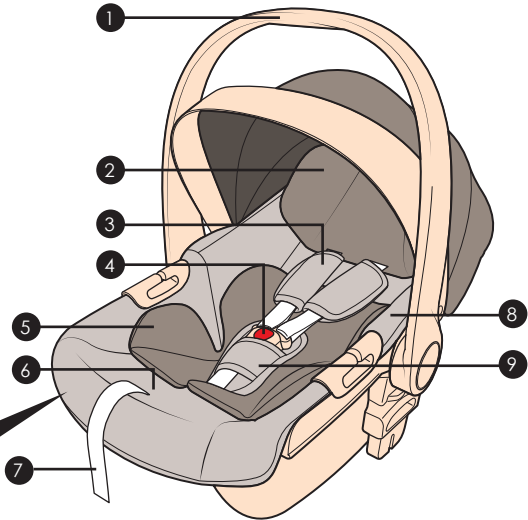

- 11 Diagonal seatbelt guide
- 12 Headrest height-adjuster
- 13 Hood
- 14 Lap belt guides
- 15 Carry handle adjuster buttons
- 16 Shell
- 17 Stroller attachment adaptors (REMOVABLE)

# Positioning the child car seat

1. The child car seat can only be used with an automatic 3-point safety belt (A) and **NOT** with a 2-point lap belt (B).

The child car seat can be secured on forward-facing back seats of the vehicle by using the existing seat belts. However, on some seats, if the installation is not properly secured, we suggest you try another seat in your vehicle.

Although not recommended, the child car seat can be used on a passenger side front seat, so long as there is no active airbag in place.

**WARNING: NEVER use on a seat with an active airbag.**

**WARNING: NEVER use on rearward or side facing vehicle seats**

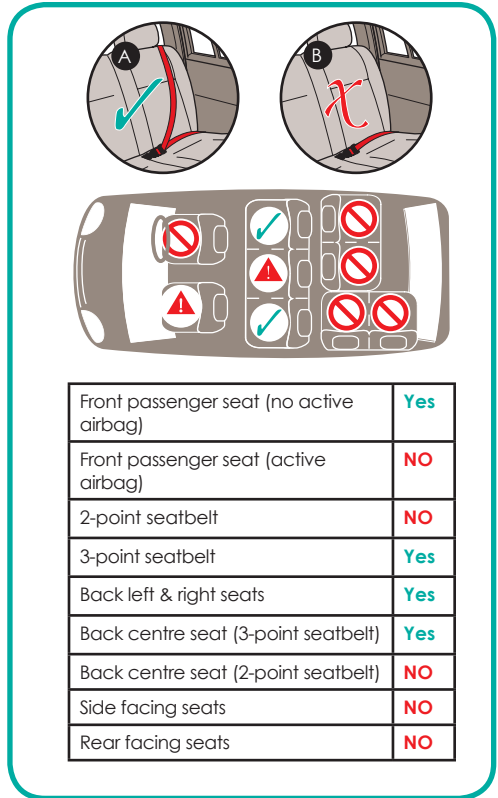

Front passenger seat (no active airbag)	Yes
Front passenger seat (active airbag)	NO
2-point seatbelt	NO
3-point seatbelt	Yes
Back left & right seats	Yes
Back centre seat (3-point seatbelt)	Yes
Back centre seat (2-point seatbelt)	NO
Side facing seats	NO
Rear facing seats	NO

## 2. When fitted on a rear seat:

The child car seat must not touch the front passenger seat.

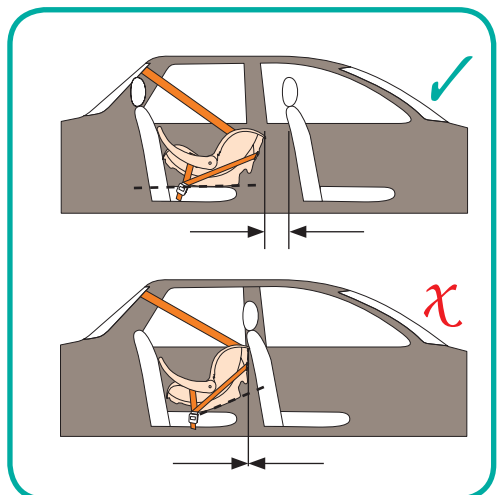

## Adjusting the carry handle

3. The carry handle has 4 positions.

- (i) Feeding/non-rocking position.
- (ii) Rocking position.
- (iii) Carrying position: Make sure handle is locked before lifting.
- (iv) Fitting position.

Press both buttons (A) and rotate the handle to the desired position.

**WARNING: NEVER place the child car seat on an elevated surface e.g. a table.**

**WARNING: NEVER place the child car seat on a soft surface e.g. cushion, mattress, pillow etc, due to risk of suffocation if child car seat tips over.**

**WARNING: NEVER leave a child unattended.**

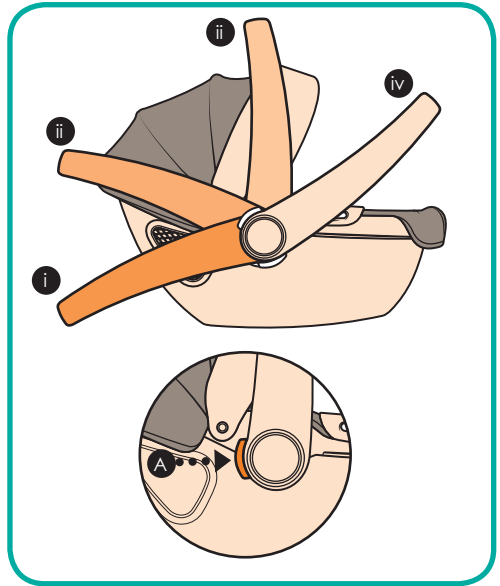

## Opening the harness

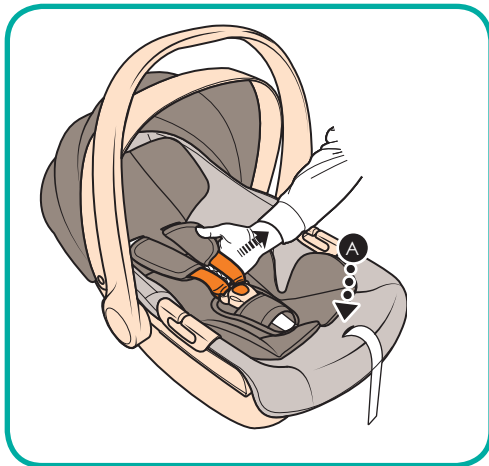

4. Press the belt adjuster button (A) and pull on the shoulder harness straps to create slack.

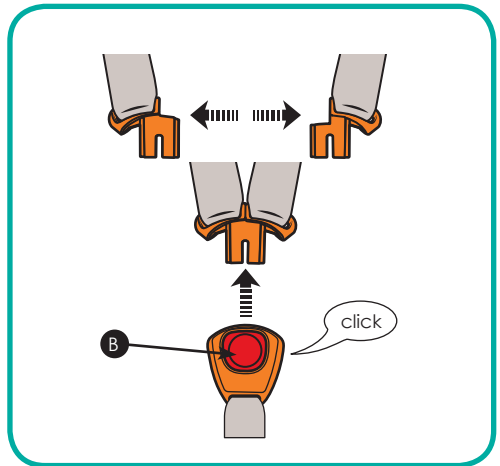

5. Press the red release button (B), unbuckle the harness and move the shoulder straps apart.



## Fastening the harness

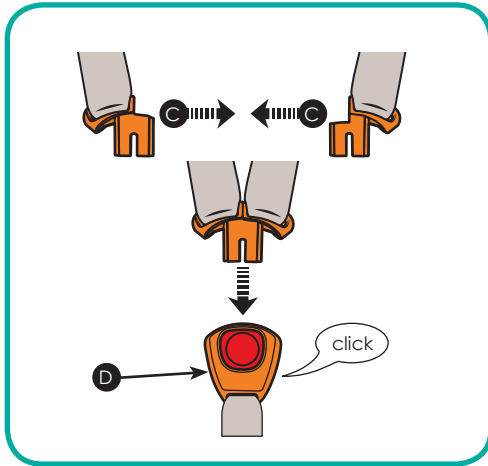

6. Connect the two shoulder strap connectors (C) and insert into the buckle (D). Ensure harness buckle is firmly clicked into place.



7. Pull the harness adjuster strap tight (E) and check straps are not twisted. Ensure you use the supplied insert cushion (F) if you are going to use the child car seat for a newborn or small baby between 40 and 60cm in length.

## Adjusting the headrest/shoulder harness height

**WARNING:** You should not attempt to adjust the headrest/harness height with a child seated in the child car seat.

8. Squeeze the headrest height-adjuster (A) and slide the headrest up or down as desired.

**Important:** If raising the headrest - ensure you have loosened the shoulder straps enough so as to prevent any resistance from the straps.

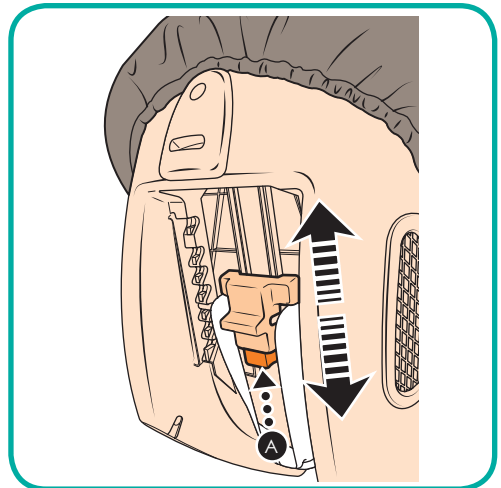

## Adjusting the headrest/shoulder harness height (cont)

9. The shoulder harness should exit the child car seat at the same height as the child's shoulders and should not exit higher or lower than this.

**WARNING:** You should not attempt to adjust the headrest/harness height with a child seated in the child car seat.

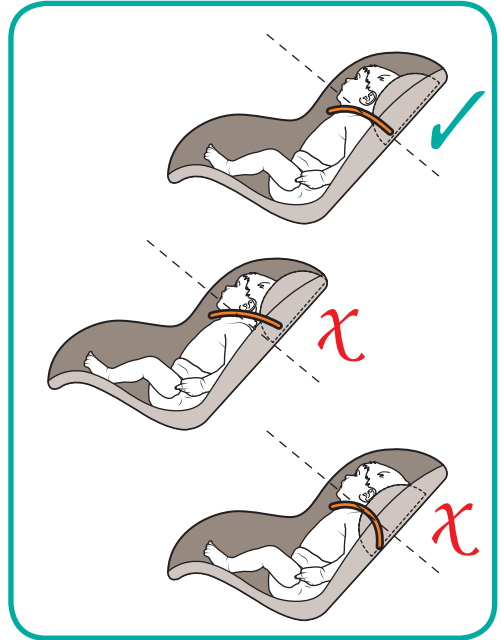

## Using the harness

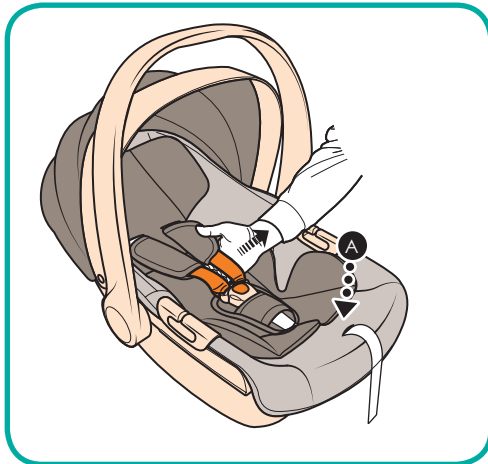

10. Press the belt adjuster button (A) and pull on the shoulder harness straps to create slack.

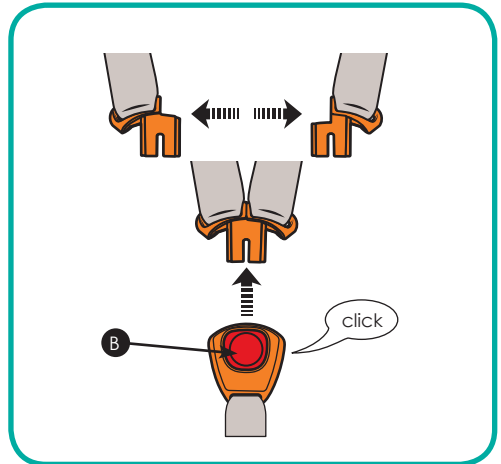

11. Press the red release button (B), unbuckle the harness and move the shoulder straps apart.

## Using the harness (continued)

**WARNING:** Do not place your child in a sleeping bag, blanket or other bulky wrapping before putting the child in the child car seat. The shoulder straps will not fit snugly and the child will not be safe.

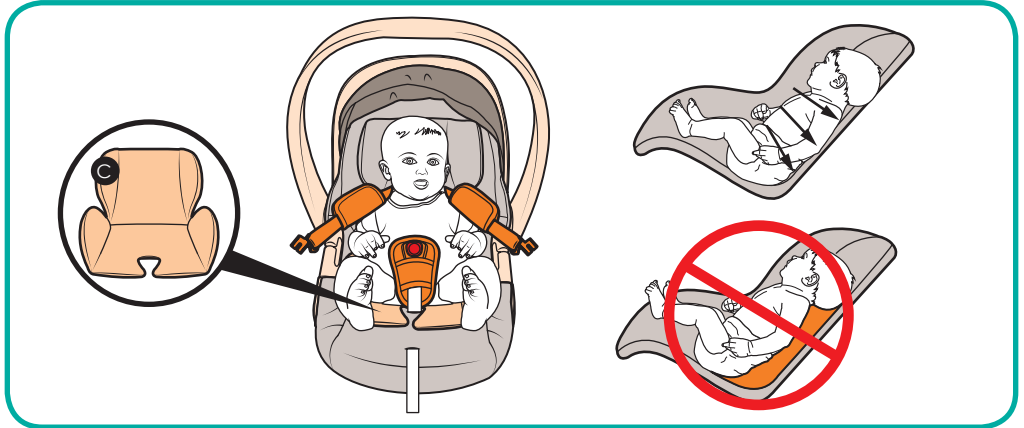

12. Place the child in the child car seat and ensure there are no spaces under the child.

**IMPORTANT:** Small babies often need extra support around the body. Always use the supplied insert cushion (C) for a small babies between 40 and 60cm in length.

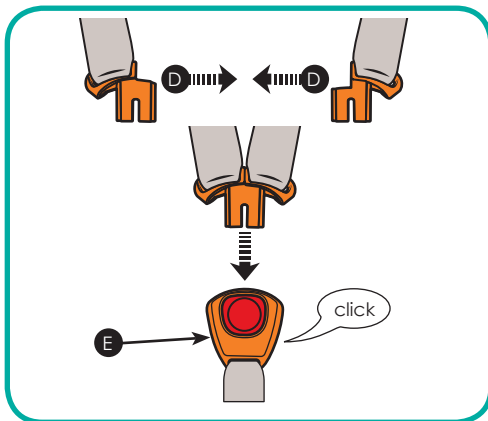

13. Place the harness over the child's shoulders and buckle up the harness. Connect the two shoulder strap connectors (D) and insert into the buckle (E). Ensure harness buckle is firmly clicked into place.



14. Pull the harness adjuster strap tight (F) and check straps are not twisted.

## Using the harness (continued)

15. The harness should allow 1 finger-width (2cm approx) of space at the top of the shoulders. This is the ideal tightness.

**Note:** Check that the buckle is secured by tugging the shoulder straps.

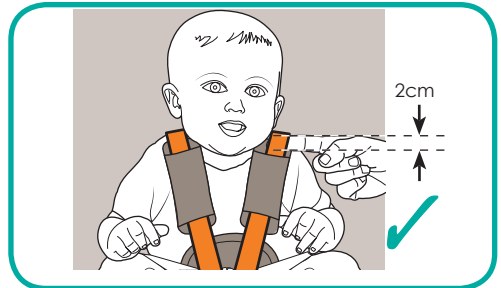

## Fitting the child seat in a vehicle

16. Choose a seat suitable for fitting the child car seat to. See page 7, 'Positioning the child car seat'.

Place the child car seat rearward-facing on the vehicle seat. Ensure the handle is in the fitting position as shown.

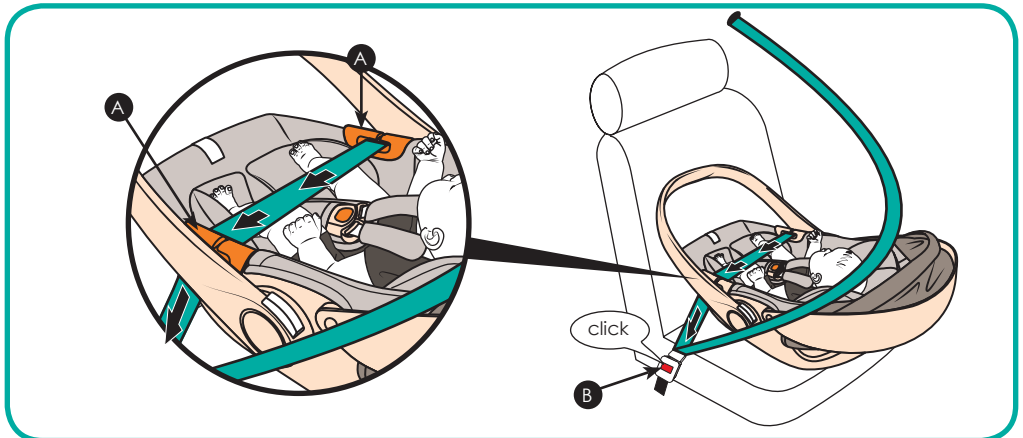
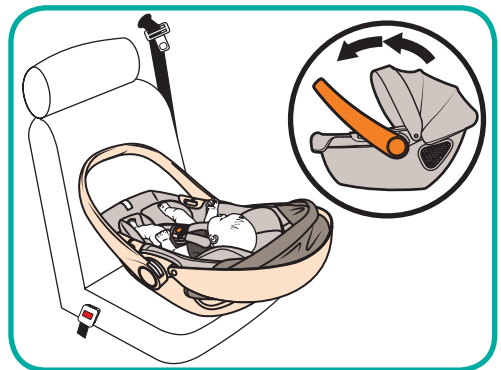

17. Place the vehicle lap belt across the child car seat and slide the lap belt into the slots (A) on both sides of the child car seat. Buckle up the vehicle seat belt (B).

## Fitting the child seat in a vehicle (continued)

18. Take the diagonal belt around the back of the child car seat and slot it into the rear seat belt guide (C).

Once the seat belts are in their correct mounting points make sure the seat belt buckle is secure and there are no twists in the belt and that all slack is removed from the lap and diagonal sections.

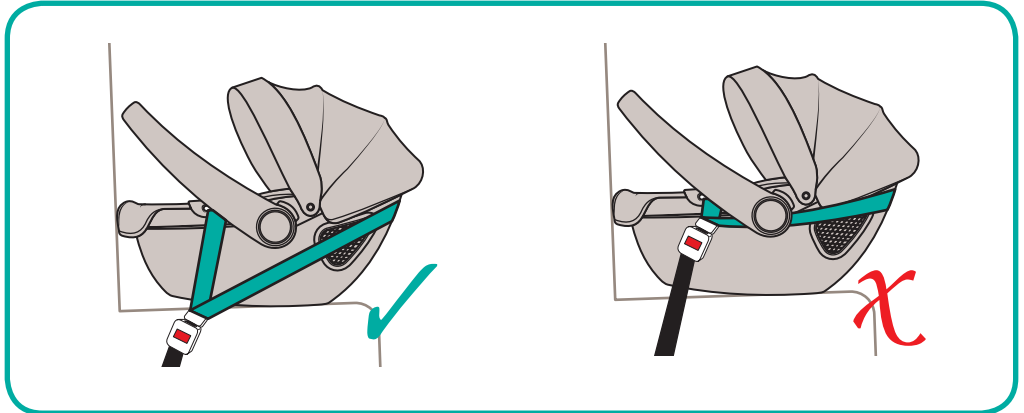

19. If the vehicle seatbelt buckle is above or touching the top edge of the shell then this car seat is not suitable for the vehicle and may cause the vehicle seatbelt to come undone in an accident.

## Using the stroller attachment adaptors

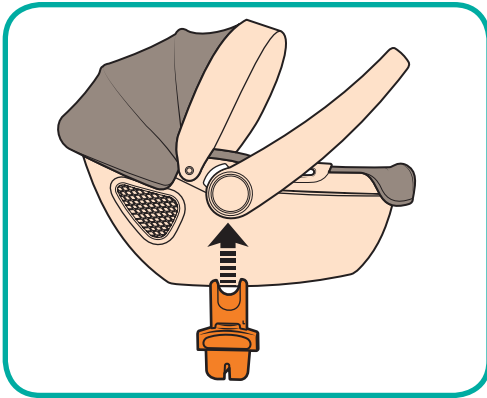

20. To attach the adaptors: push each adaptor into the socket directly below the carry handle joint.

**Note:** There are two adaptors. Each adaptor is marked with a letter "L" for left and "R" for right and will only fit one side of the car seat.

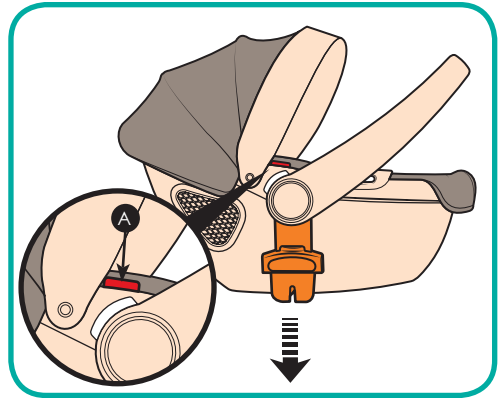

21. To remove the adaptors: press the red release button (A) and pull the adaptor out from the socket.

**Note:** The release button (A) is located under the edge of the seat fabric.

## Attaching the seat to the chassis

**WARNING! DO NOT attempt to attach the car seat to the stroller with a child in the car seat.**

22. Hold the car seat so that it is facing the stroller handle. Position the car seat adaptors (A) above the mounting points (B) and push the seat downwards until it clicks into place.

**Note:** The car seat can only be fitted parent facing (as shown).

**Attention:** Lift the car seat to ensure it is firmly attached to the stroller chassis.

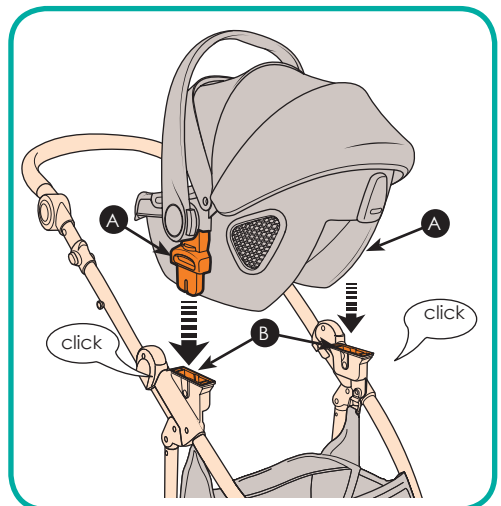

## Removing the seat from the chassis

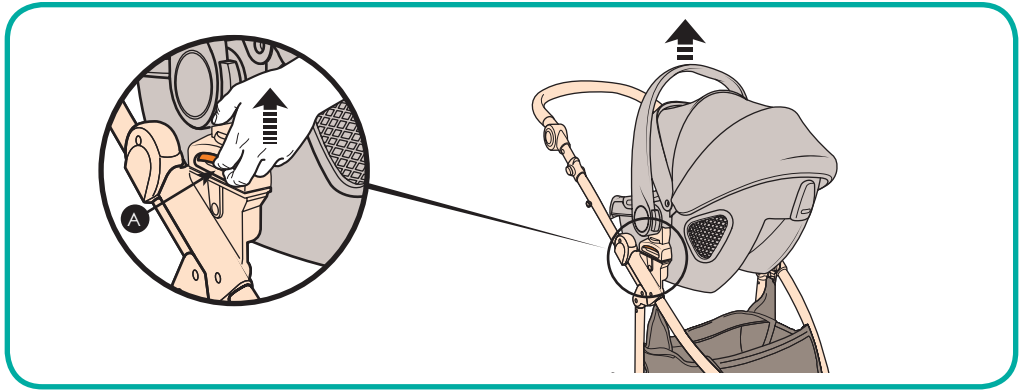

23. Standing in front of the chassis, lift up the release catches (A) on each side of the car seat and lift it from the chassis.

## Removing the seat cover

**WARNING! Never use the child car seat without the covers.**

The seat cover can be removed for washing, however the headrest cover cannot be removed. See "Care and Maintenance" for details on cleaning the removable and non-removable covers.

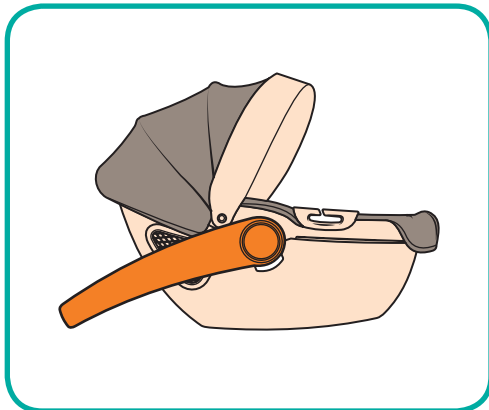

24. Place the carry handle in the non-rocking position.

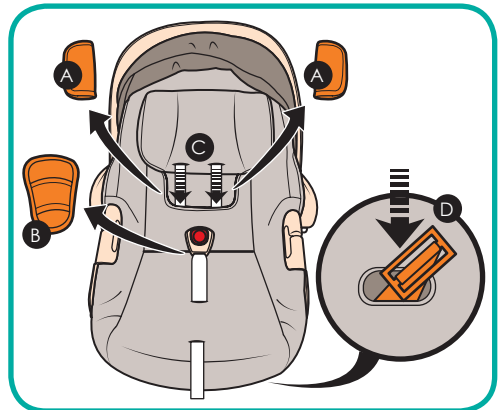

25. Remove the shoulder pads (A) and crotch pad (B). Place the shoulder straps (C) behind the seat cover. Remove the buckle (D).

## Removing the seat cover (continued)

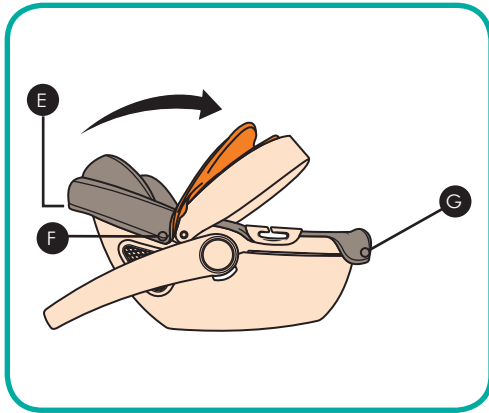

26. Remove the hood fabric from around the back of the seat and pull the hood forward.

Unhook all the plastic clips (E), (F), (G) and remove the elastic loops from the two clips (F) near the hood fixing point.

28. Pull the seat cover up from the back of the seat and carefully pull it over the headrest and free from the seat.

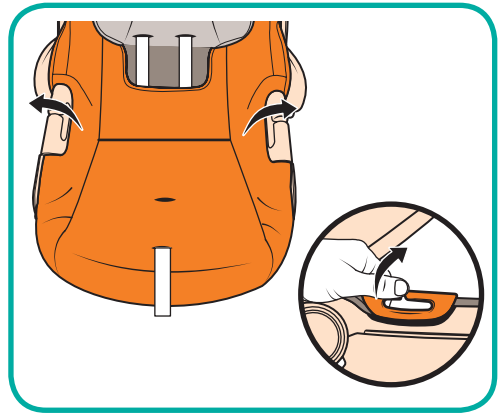

27. Carefully pull the cover out from under the lap belt guides - taking care not to break the elastic.

**Tip:** Gently ease the lap belt guides inwards to open a gap on the outside and allow the elastic to be removed.

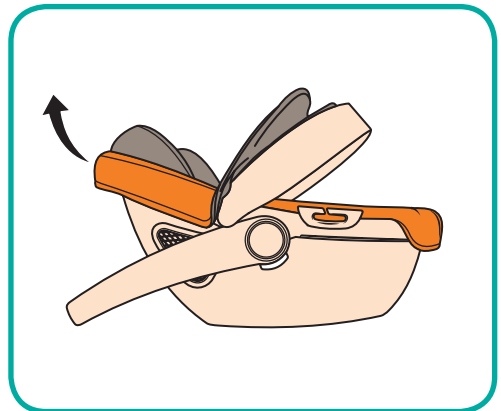

## Refitting the seat cover

**WARNING! Never use the child car seat without the covers.**

Reverse steps 24-28 to re-fit the seat cover.



## Removing the hood fabric

29. Remove the hood fabric from around the back of the seat and pull the hood forward.

Unhook plastic clips (A) and remove the elastic loops from the two clips.

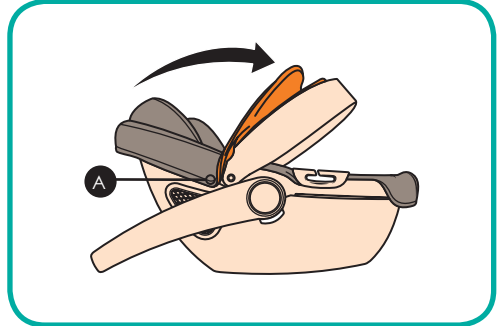

30. Remove the hood fabric from the clips (B) along the inside of the plastic hood visor.

Reverse steps 29-30 to re-fit the hood

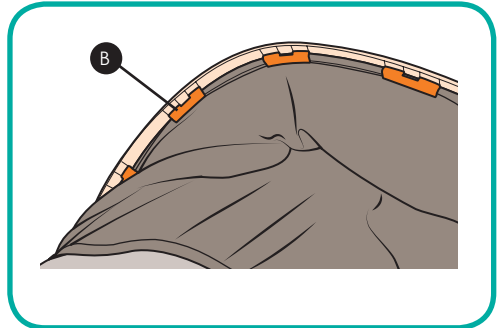

## Care and maintenance

- 1) Store this child car seat, when not in use, in a safe place away from direct sunlight.
- 2) **DO NOT** place heavy objects on top of it.
- 3) Always store the child car seat in a dry environment.
- 4) **DO NOT** store the child car seat near a direct heat source such as a radiator.

### Removable Fabrics

- 1) All the removable fabrics can be hand washed with pH neutral soap and cold water.
- 2) **DO NOT** press, iron, dry clean, tumble dry or wring the covers.
- 3) **DO NOT** use solvents, caustic or abrasive cleaning materials.
- 4) Dry flat, away from direct heat and sunlight.
- 5) If the seat covers need to be replaced only use parts certified by the manufacturer. They are the only ones that are guaranteed to have been safety tested and designed to fit this seat.

### Non-removable Headrest Cover

- 1) Wipe with a damp cloth or sponge. **DO NOT** soak the headrest cover.
- 2) **DO NOT** use solvents, caustic or abrasive cleaning materials.
- 3) Dry flat, away from direct heat and sunlight.

### Plastic/Metal Parts

- 1) Wipe clean only, using a mild soap and warm water.
- 2) **DO NOT** immerse the car seat in water.
- 2) You **MUST NOT** remove, dismantle or alter any part of the seat shell.
- 3) You **MUST NOT** oil or lubricate any part of the seat shell.

### Inspection

- 1) Check your child car seat regularly for wear and tear.
- 2) The child car seat may have a slight rattle when not in use, this is normal. If in any doubt, contact the retailer immediately.
- 3) Check the adjustable parts of your child seat at intervals of about 6 months to ensure it is still fits correctly for your growing child.





[www.mychild.co.uk](http://www.mychild.co.uk)

Customerservice@kooltrade.co.uk  
Imported by Kooltrade Ltd. M34 3QA  
Tel: 0161 335 2508