

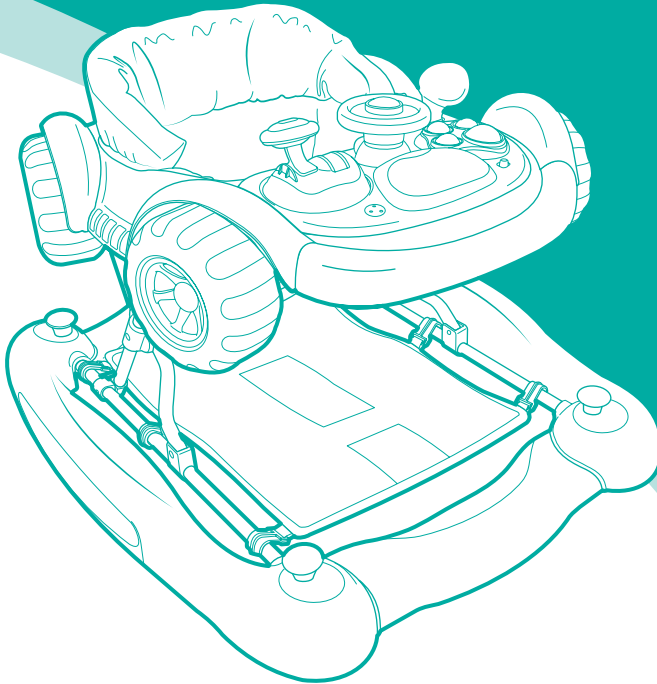

MY CHILD®

Coupé Walker

Instruction manual



IMPORTANT! READ CAREFULLY AND KEEP FOR FUTURE REFERENCE

This product is intended only for a child who can sit up by itself and until it is able to walk by itself or weighs more than 12 kg.

BS EN 1273:2020.

Safety instructions



WARNING:

- Never leave the child unattended.
 - The child will be able to reach further and move rapidly when in the baby walking frame:
 - Prevent access to stairs, steps and uneven surfaces.
 - Guard all fires, heating and cooking appliances.
 - Remove hot liquids, electrical cables and other potential hazards from reach.
- Prevent collisions with glass in doors, windows and furniture.
 - This product is intended only for a child who can sit up by itself and until it is able to walk by itself or weighs more than 12 kg.
 - This baby walking frame should be used only for short periods of time (e.g. 20 min).
 - Do not use the product if any components are broken or missing.
 - Do not use accessories or replacement parts other than those approved by the manufacturer.
 - Never use the baby walking frame without the supplied anti-fall blocks attached.
 - Never use the baby walking frame without the supplied wheels attached.

Battery warnings

Only use the recommended batteries observing correct voltage and size. Always take care to insert your batteries correctly, observing the plus and minus marks on the battery and appliance.

Do not mix new and used batteries.

Do not mix different types of batteries.

Always remove batteries (whether they are dead or not) if you are not going to use the product for long periods (as batteries may leak and cause damage).

Never attempt to re-charge ordinary (non-rechargeable) batteries.

Remove rechargeable batteries before attempting to charge them.

Do not short-circuit the supply terminals

Batteries should always be changed by an adult.

Keep batteries out of reach of children.

Children can choke on batteries. If swallowed seek medical advice immediately.

Battery disposal

The crossed out wheellie bin symbol indicates that the product must not be disposed of with other household waste. Do not treat batteries (old or new) as household waste. Never dispose of batteries in a fire this may cause them to explode. Batteries (old or new) should be disposed of by taking them to a designated collection point or recycling facility.



Care and maintenance

- To prolong the life of your nursery product keep it clean and do not leave it in direct sunlight for extended periods of time.
- Removable fabric covers and trims may be cleaned using warm water with a household soap or a mild detergent. Allow it to dry fully, preferably away from direct sunlight.
- If the wheels squeak - use a silicon based spray ensuring it penetrates the wheel and axle assembly.
- Do not dry clean, or use bleach.
- Do not machine wash, tumble or spin dry, unless the care labelling on the product permits these methods.
- Non removable fabric covers and trims may be cleaned using a damp sponge with soap or mild detergent. Allow it to dry completely before folding or storing it away.
- In some climates the covers and trims may be affected by mould and mildew. To help prevent this occurring, do not fold or store the product if it is damp or wet. Always store the product in a well ventilated area.
- Always check parts regularly for tightness of screws, nuts and other fasteners - tighten if required. If any parts are bent, torn, worn or broken please contact Customer Service.

Your 3 year warranty

Whilst we make and test our products to the highest standards of durability there's always a small chance of a hiccup! Our promise is to repair, replace or refund a MyChild product that has an identified manufacturing defect from the date of purchase for a full 3 years thereafter at no extra cost.

However, you must register within 28 days of the date of purchase to receive the full 3 years guarantee!

To receive your full guarantee you can register your product by:
visiting <https://mychild.co.uk/pages/warranty> and complete the warranty form,
or by telephone on 0161 335 2508.

Welcome

Thank you for purchasing the MyChild Coupé Walker.
Please read the instructions and warnings carefully before use to ensure safe and satisfactory operation of this product.

Your child's safety is your responsibility. If you have a query with this product or require replacement parts, please contact the MyChild Helpline on 0161 335 2508.

Lay out the parts on a soft level surface and compare to the part/fixings checklist below. Do not discard any packaging until you are sure that you have all the parts.

WARNING! Assembly by an adult. Keep away from children until fully assembled. Keep children clear during assembly as pack contains small parts which may present a choking hazard.

Parts checklist

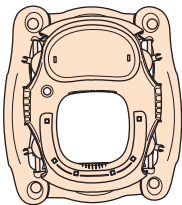

1

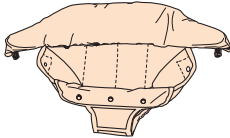

2

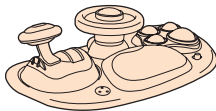

3

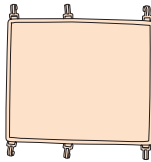

4



5



6

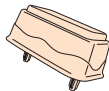

7

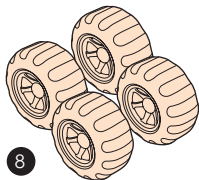

8

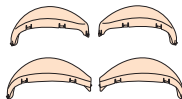

9



10

Contained in your carton are:

Nº	Part	Qty
1	Walker body	1
2	Seat unit	1
3	Musical play tray*	1
4	Footrest pad	1
5	Front wheels	2
6	Rear wheels	2
7	Anti-fall blocks	6
8	Car wheels	4
9	Mud guards	4
10	Wing mirror	1

*Actual style may vary

You will require one Phillips screwdriver (not supplied).



Opening and closing the baby walker

WARNING! NEVER adjust the height when your child is in the walker. DO NOT place your child in until you have adjusted the height and made sure it is locked in place.

1. **To open:** hold either side of the upper part of the walker and pull upwards to one of the three height positions. Ensure the upper part of the walker clicks into position.

Note: There is a click for each of the three height positions. The walker is fully open when you hear the 3rd click.

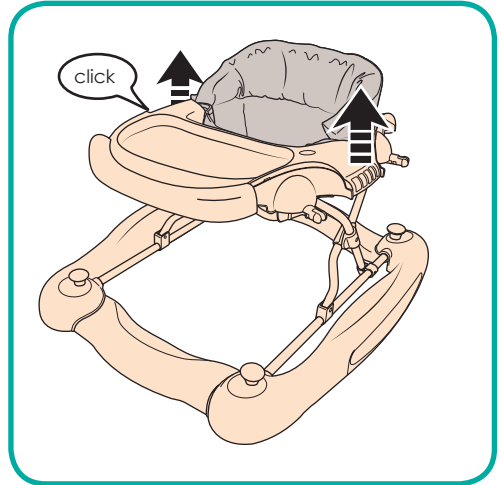

2. **To close:** Hold the front of the walker and at the same time, turn and pull the locking mechanism forward and lower the upper part of the walker all the way down.

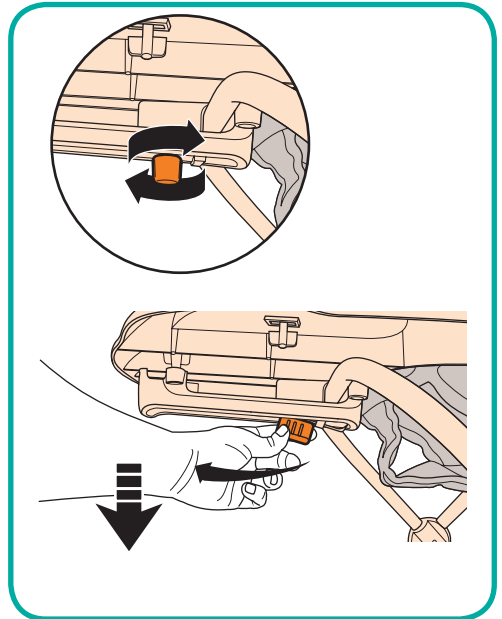

3. **To adjust the height:** The simplest method to adjust the height is to lower the upper part of the walker all the way down (as above, in step 2) then pull the upper part of the walker back up so that it clicks into one of the three height positions.

Attaching the walker's anti-fall blocks

1. **Attaching the anti-fall blocks:** With the baby walker upside down and fully folded down, place the anti-fall blocks around the walker as shown, inserting the two plastic stems on each block into the holes on the walker's underside.

WARNING! DO NOT USE THE WALKER WITHOUT THE ANTI-FALL BLOCKS ATTACHED.

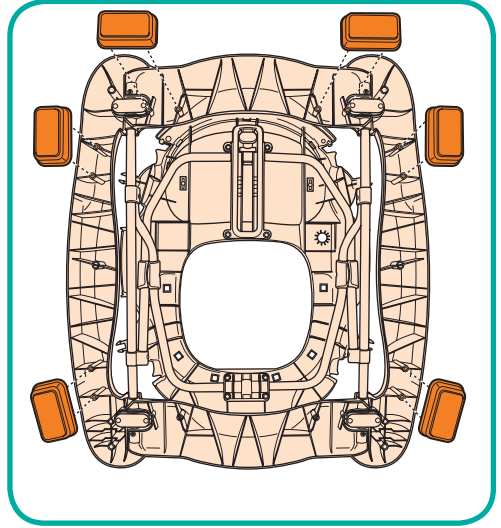

Attaching the walker's front and rear wheels

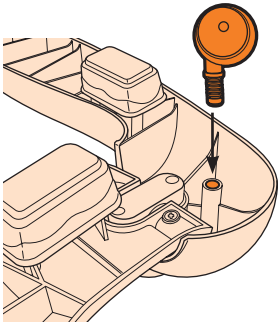

1. Attaching the front wheels:

With the baby walker still upside down and fully folded down, insert both front wheels fully into each round hole on either corner at the front of the walker.

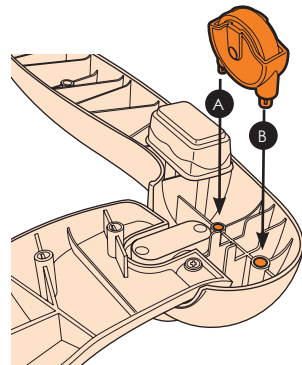

2. Attaching the rear wheels:

With the baby walker still upside down and fully folded down, insert both rear wheels into the two round holes on either corner at the rear of the walker.

Note: Ensure the thin pin (A) goes into the smaller of the two holes and that the wide pin (B) goes into the larger hole.

Fitting the seat unit

1. Lower the walker all the way down and place the walker on a flat level surface. Place the seat unit into the centre of the baby walker.

2. Attach all plastic clips on the seat unit to the walker body in the following order:

A. (See Fig 1) Starting with the seat unit's arm rests, insert clips through the holes (1) and (2) in the seat unit fabric then insert the clips into holes (A1) and (A2) on the walker body.

B. Next, attach the seat unit's backrest by pushing the plastic clips into holes (B1), (B2), (B3) and (B4). Start from one side and work your way around. Grip the back of the seat unit as low down as possible (Fig 2), feeling for the head of the clip and ensuring the clip is lined up with its hole, push the clip in (Fig 2a).

Note: If a clip is not protruding from the seat unit you may need to locate it and pull it through the hole in the seat cover.

C. Finally insert the pins at the front of the seat unit into keyhole slots (C1), (C2) and (C3). (Fig 3)

WARNING: Ensure all pins and clips are properly attached before placing your child in the seat.

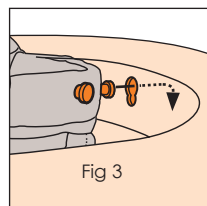
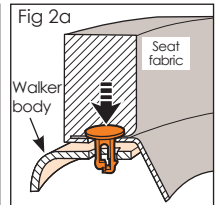
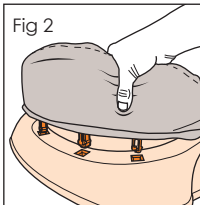
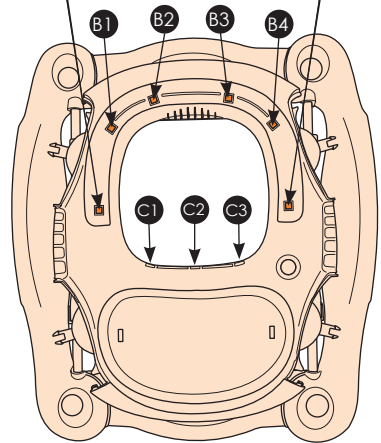
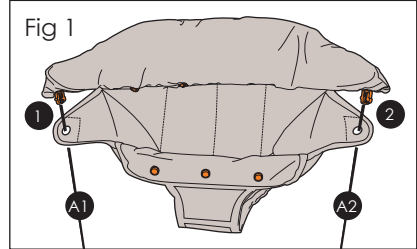

The footpad

1. The footpad must be fitted in the rocker mode, and when you don't want your child to move about in the walker mode.

Attach using the six clips on the footpad and hook over the side bars on either side of the base.

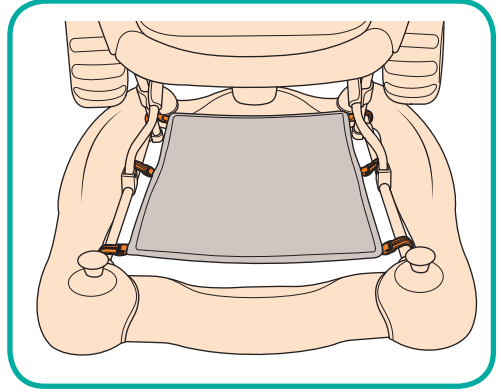

Fitting the mudguards

1. **IMPORTANT:** The mudguards are numbered from 1 to 4. They must be fitted to the corresponding numbers on the walker body.

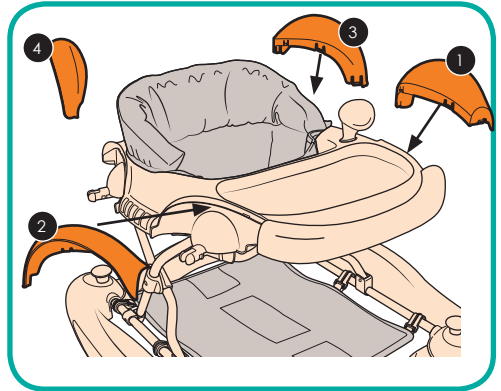

2. Match the number on the underside of the mudguard with the number on the walker body.

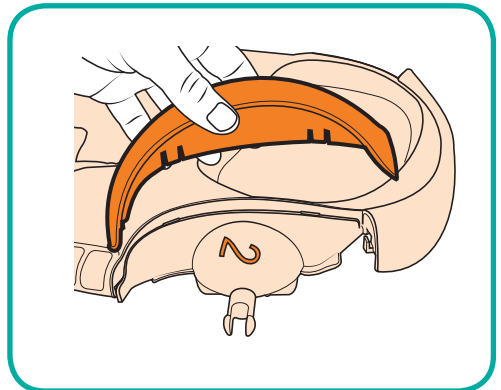

Fitting the mirror

1. Press the wing mirror firmly into the slot on the walker body.

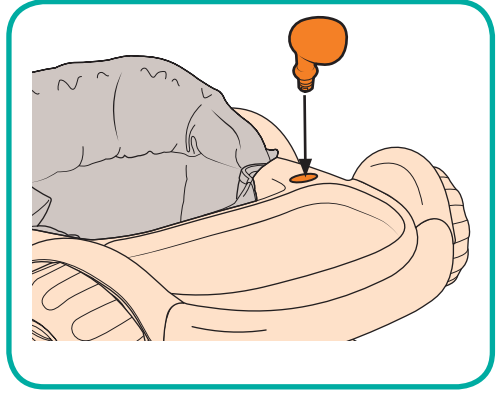

Fitting the car wheels

1. Press the wheels firmly onto the mounting points at each corner of the walker body.

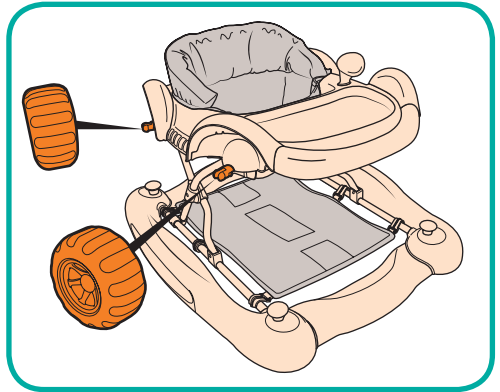

Using walker and rocker modes

ATTENTION: Ensure the footpad is fitted whilst in the rocker mode

1. Working on one side at a time, pull up both locking knobs (A).

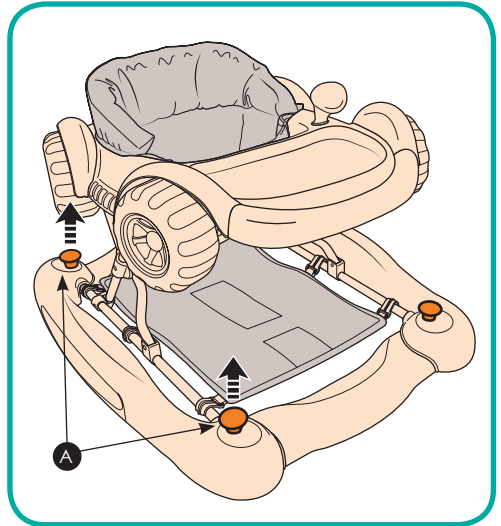

2. Whilst pulling up on both locking knobs, turn the base 90 degrees upwards into the rocker mode. Repeat on the opposite side and check that both sides of the base are locked in position.

To convert back: Pull both locking knobs (A) and turn the base 90 degrees downwards into the walker mode. Repeat on the opposite side and check that both sides of the base are locked in position.

WARNING! DO NOT convert from rocker to walker or vice-versa whilst your child is seated in the walker.

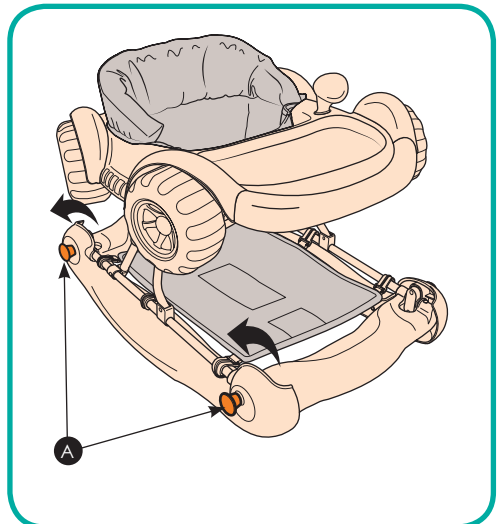

Musical play tray

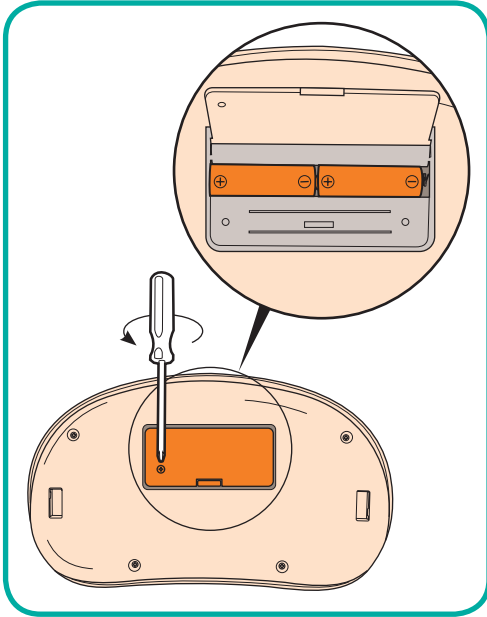

1. Using a Phillips screwdriver, unscrew the battery cover on the underside of the musical play tray.

Insert 2 x 1.5V AA batteries (not supplied) ensuring the correct battery orientation is observed and then reattach the cover, replacing the screw, making certain it is not overtightened.

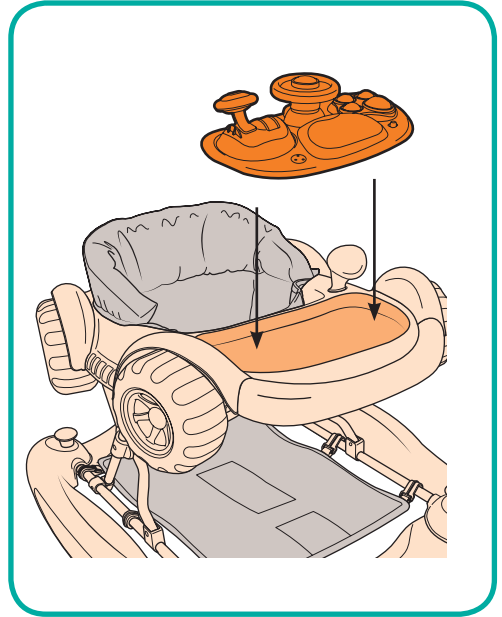

2. Place the toy tray into the recess on top of the walker body.

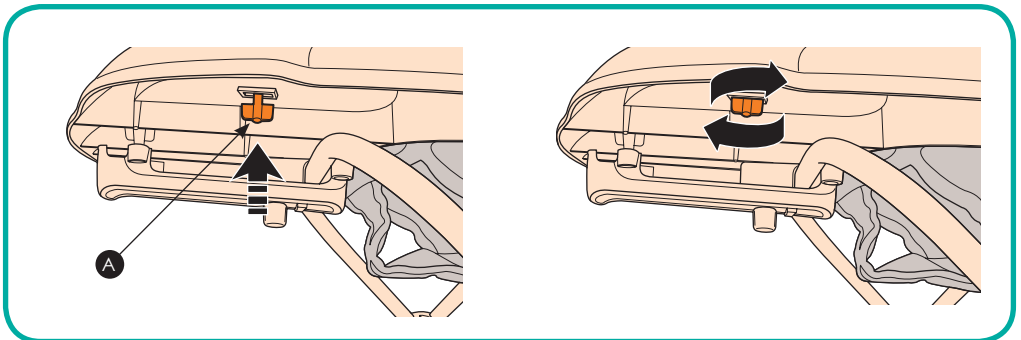

3. Secure the toy tray to the walker body by pushing the tabs (A) on the underside of the walker body, into the corresponding holes in the toy tray and then turning the tabs to fix the tray in position.



www.mychild.co.uk

Customerservice@kooltrade.co.uk
Imported by Kooltrade Ltd. M34 3QA
Tel: 0161 335 2508