

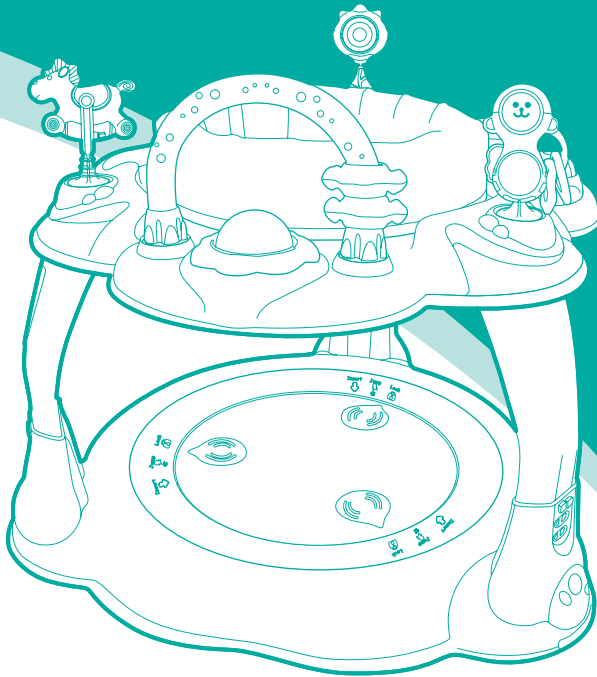

Twizzle Activity Centre

Instruction manual



INSTRUCTIONS: READ THE INSTRUCTIONS CAREFULLY BEFORE USE AND KEEP THEM FOR FUTURE REFERENCE.

The child may be hurt if you do not follow these instructions.

Suitable for children who can sit up unaided, approximately from 6 months. It is not intended for children who can walk by themselves and weigh more than 12kg.

Safety instructions



Warning: Adult assembly required.

Warning: Not to be used by children over 36 months. Due to insufficient strength.

Warning: Use the activity centre only if your child meets all of the following conditions:

- Your child is at least 6 months old and less than 36 months old.
- Your child can sit up unaided.
- Your child is less than 76.2cm tall.
- Your child weighs less than 12kg.

Warning: DO NOT place children who can stand or walk on their own in the activity centre.

Warning: Do not use the activity centre in dangerous conditions or situations.

Warning: NEVER leave the child unattended in the activity centre. ALWAYS keep child in view while child is in the product.

Warning: NEVER move the activity centre while the child is in the seat.

Warning: It can be dangerous to allow other children to play near the activity centre.

Warning: Strings can cause strangulation! DO NOT place items with string around child's neck, such as hood strings or dummy cords. DO NOT suspend string over the product or attach strings to toys or place near curtain blinds cords or other hanging cords. Do not add any strings or straps to any part of the activity centre.

Warning: DO NOT use any parts other than those supplied or recommended by the manufacturer.

Warning: Only seat your child in the activity centre if the jump platform is attached.

Warning: DO NOT place the activity centre on an elevated surface or near steps or stairs. A child's movement can slide the activity centre.

Warning: To avoid the activity centre toppling over, place it on a flat, level floor. Adjust legs to same height so that the tray is level before placing child in the product.

Warning: For INDOOR use only.

Warning: Do not use the product if any of the toys, seat or structural parts are damaged. Remove the child immediately if you find any small loose parts or sharp/broken parts.

Important: Care should be taken in unpacking and assembly.

Important: Examine product frequently for damaged, missing, or loose parts.

Battery warnings

Only use the recommended batteries observing correct voltage and size.

Always take care to insert your batteries correctly, observing the plus and minus marks on the battery and appliance.

Do not mix new and used batteries.

Do not mix different types of batteries.

Always remove batteries (whether they are dead or not) if you are not going to use the product for long periods (as batteries may leak and cause damage).

Never attempt to re-charge ordinary (non-rechargeable) batteries.

Remove rechargeable batteries before attempting to charge them.

Do not short-circuit the supply terminals

Batteries should always be changed by an adult.

Keep batteries out of reach of children.

Children can choke on batteries. If swallowed seek medical advice immediately.

Battery disposal

The crossed out wheellie bin symbol indicates that the product must not be disposed of with other household waste. Do not treat batteries (old or new) as household waste. Never dispose of batteries in a fire this may cause them to explode.

Batteries (old or new) should be disposed of by taking them to a designated collection point or recycling facility.

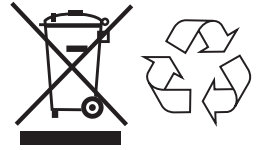

Your 3 year warranty

Whilst we make and test our products to the highest standards of durability there's always a small chance of a hiccup! Our promise is to repair, replace or refund a MyChild product that has an identified manufacturing defect from the date of purchase for a full 3 years thereafter at no extra cost.

However, you must register within 28 days of the date of purchase to receive the full 3 years guarantee!

To receive your full guarantee you can register your product by: visiting www.mychild.co.uk/warranty.html and complete the warranty form, or by telephone on 0161 335 2508.

Welcome

Thank you for purchasing the MyChild Twizzle Activity Centre. Please read the instructions and warnings carefully before use to ensure safe and satisfactory operation of this product.

Your child's safety is your responsibility. If you have a query with this product or require replacement parts, please contact the MyChild Helpline on 0161 335 2508.

Lay out the parts on a soft level surface and compare to the part/fixings checklist below. Do not discard any packaging until you are sure that you have all the parts.

WARNING! Assembly by an adult. Keep away from children until fully assembled. Keep children clear during assembly as pack contains small parts which may present a choking hazard.

Parts checklist

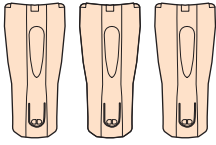

1

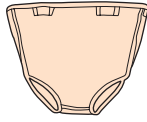

2



3

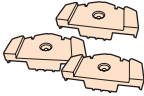

4

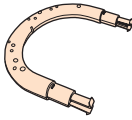

5

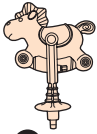

6



7



8

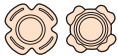

9



10

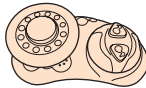

11

Contained in your carton are:

| Nº | Part | Qty |
|----|-----------------|-----|
| 1 | Legs | 3 |
| 2 | Seat fabric | 1 |
| 3 | Screws | 3 |
| 4 | Cover plates | 3 |
| 5 | Toy bar | 1 |
| 6 | Toy horse | 1 |
| 7 | Toy flower | 1 |
| 8 | Toy monkey | 1 |
| 9 | Toy rings | 2 |
| 10 | Toy bar housing | 2 |
| 11 | Musical toy | 1 |
| 12 | Seat unit * | 1 |
| 13 | Footplate | 1 |
| 14 | Seat tray | 1 |
| 15 | Base | 1 |

* Comes attached to seat tray (14)

You will require one Phillips screwdriver (not supplied).

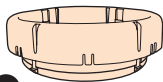

12

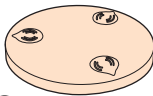

13

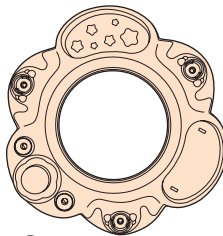

14

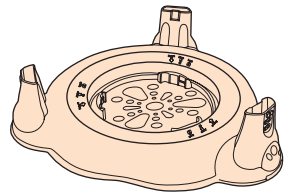

15

Base assembly

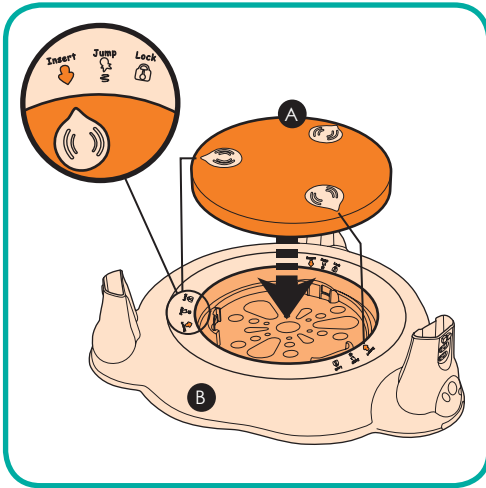

1. Insert the footplate (A) into base (B), ensuring you line up the arrows on the footplate with the 'Insert' arrow on the base.

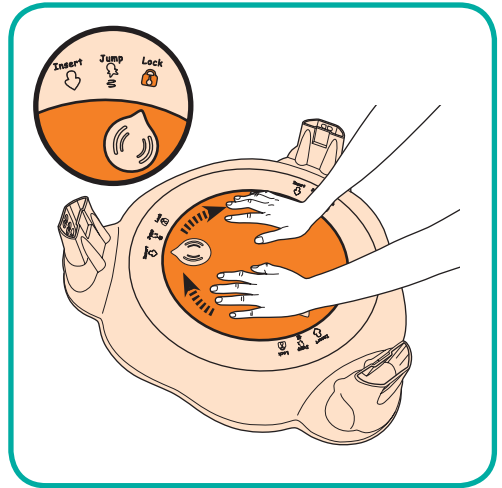

2. Press down on the footplate and rotate it to the right, till the arrows on the footplate line up with the 'Lock' arrows on the base. The base is now locked into position.

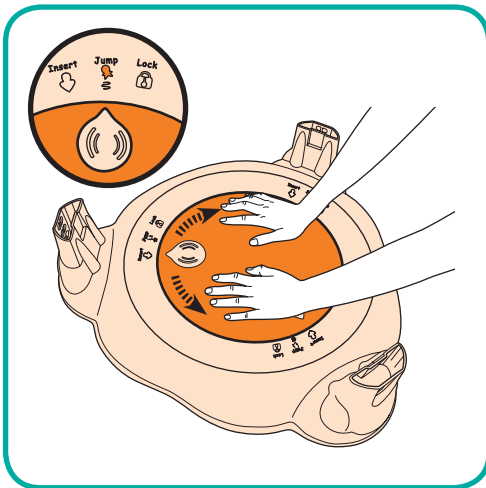

3. Jump setting: The jump setting (once fully assembled) allows your child to bounce on the footplate. To prevent your child from bouncing on the footplate turn it till the arrows point to 'Lock' again.

NOTE: DO NOT let your child use the footplate on the 'Insert' setting.

Legs assembly

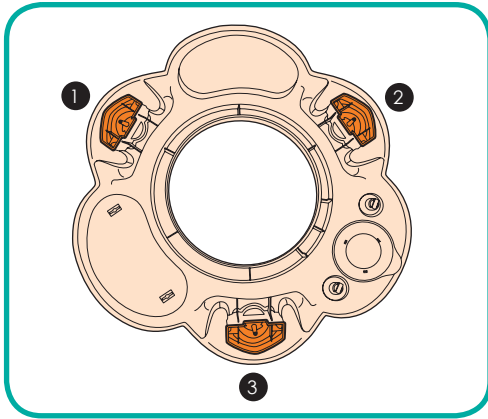

1. Attach legs at points (1), (2) and (3) on the underside of the seat tray.

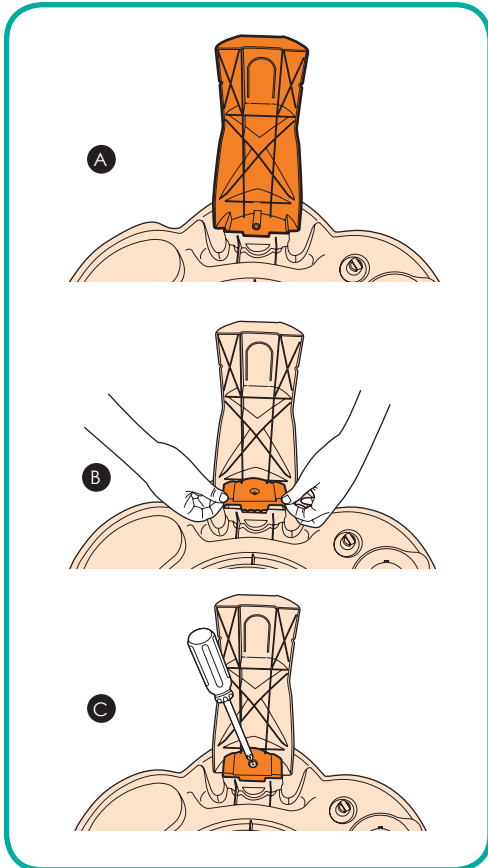

2. Working on one leg at a time.

(A) Insert a leg.

(B) Place a cover plate on.

(C) Secure with a screw. Be careful not to overtighten the screw.

Repeat for remaining legs.

Seat tray and base assembly

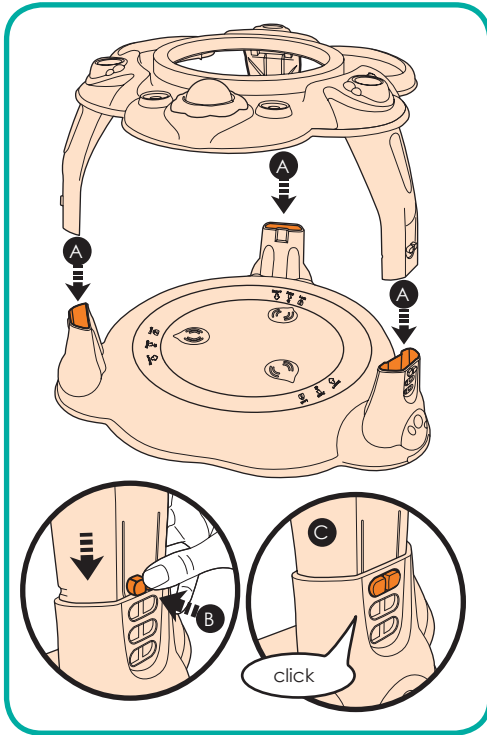

1. Line up all the legs (A) with the fixing points on the base.

Press in the button (B) on each leg and push the leg into the fixing point on the base until they 'click' into place (C).

Repeat on remaining legs. Ensure all legs are at the same height.

Musical toy assembly

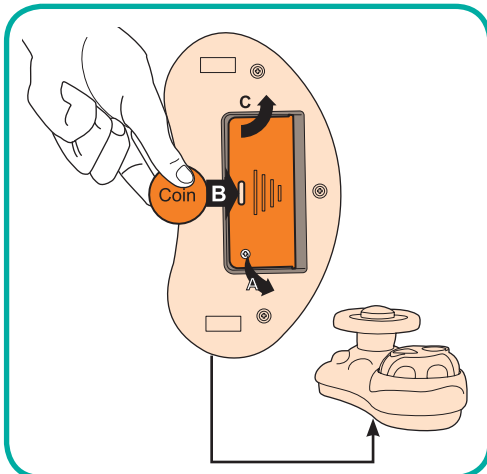

1. Using a Phillips screwdriver remove screw (A) from battery compartment on the underside of the musical toy.

Using the edge of a coin (B), open the battery compartment (C).

WARNING: Assembly by an adult.

Musical toy assembly (continued)

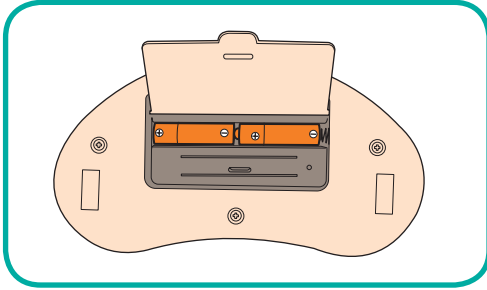

2. Insert 2 x 1.5V AA batteries (not supplied) ensuring the correct battery orientation is observed and then reattach the cover, replacing the screw and ensuring it is not over tightened.

ATTENTION: Refer to 'Battery warnings' on page 2.

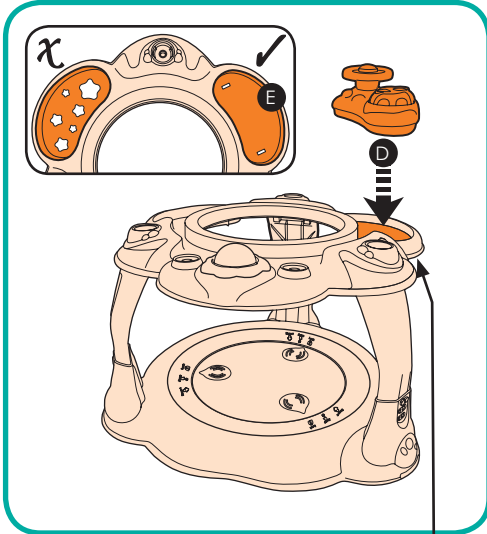

3. Insert the musical toy (D) into the recess on the seat tray.

Note: the toy should be placed into the recess with the two white plastic tabs (E).

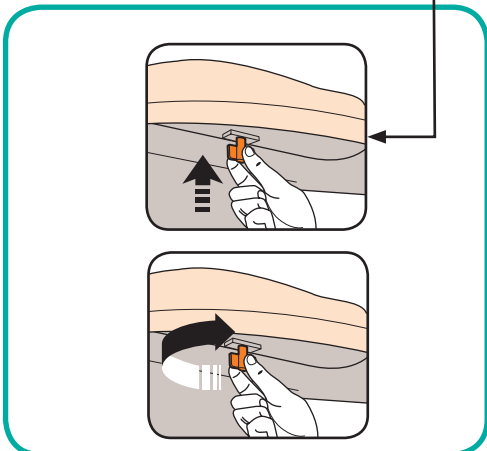

4. With the musical toy seated in the recess, locate the white plastic tabs on the underside of the seat tray.

Push the two plastic tabs up and rotate clockwise to lock the musical toy in place.

Toys and toy bar assembly

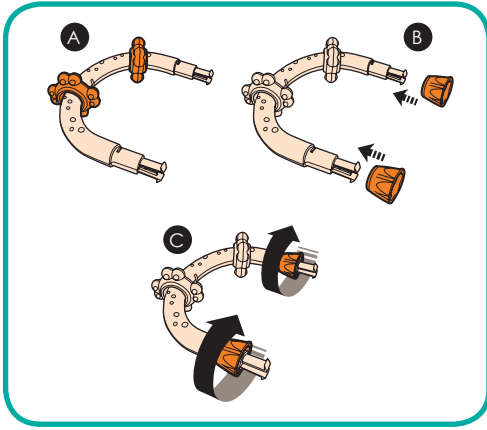

1. To assemble the toy bar:

- (A) Thread the two toy rings onto the toy bar.
- (B) Place a toy bar housing on each end of the toy bar.
- (C) Rotate toy bar housings to the right to tighten.

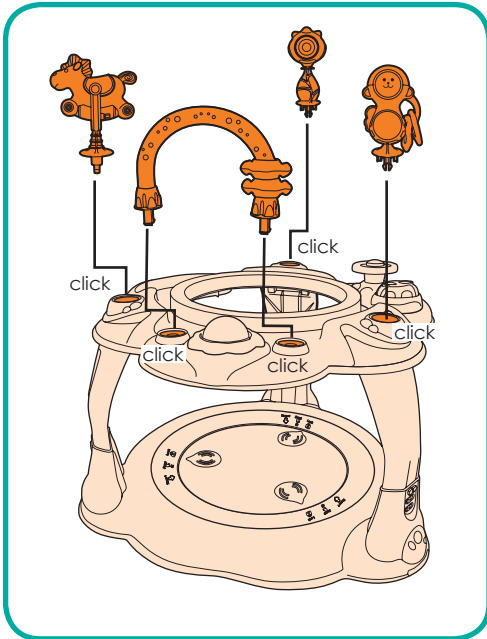

- 2. Align the toys and toy bar with the mounting points on the seat tray and 'click' them into place. Pull the toy bar and 3 toys to check they are firmly attached.

NOTE: The toys are not designed to be removed once attached.

WARNING: Never attempt to lift or move the activity centre by holding onto the toys.

Seat unit assembly

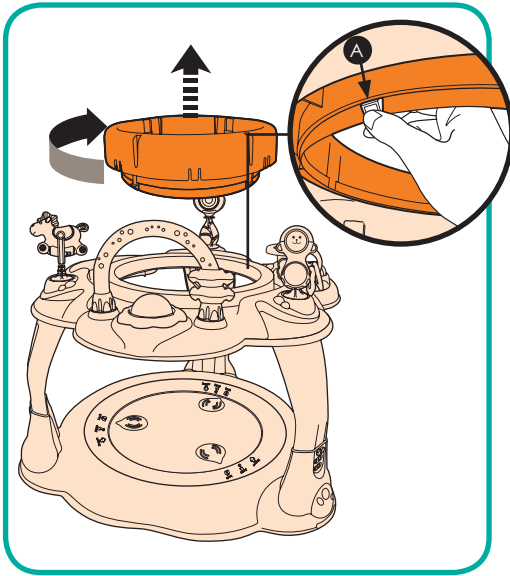

1. Remove the seat unit from the seat tray by pressing the clips (A) on the underside of the seat unit whilst lifting and rotating the seat unit.

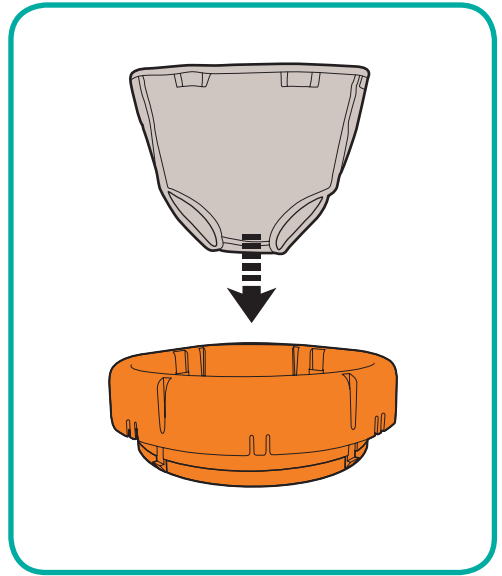

2. Place the seat fabric into the seat unit.

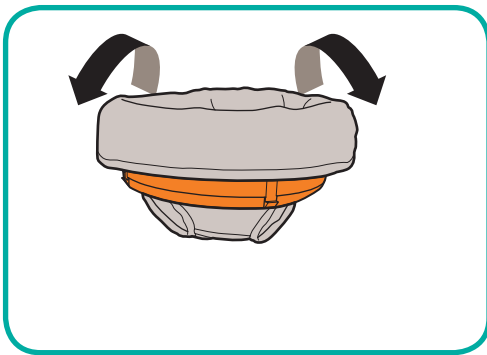

3. Fold the seat fabric over the seat unit.

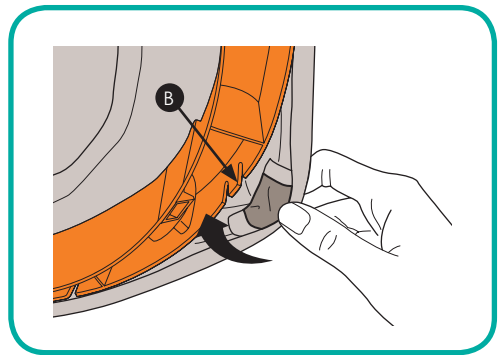

4. Hook the 8 webbing strips on the underside of the seat fabric over the tabs (B) on the seat unit.

Seat unit assembly (continued)

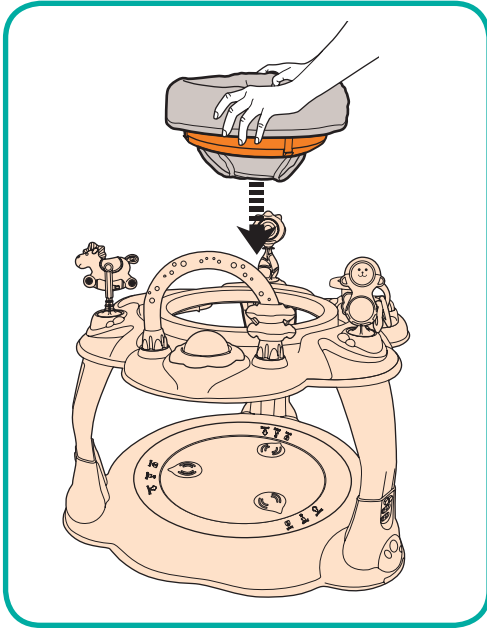

5. Insert the assembled seat unit into the seat tray, pressing it down until it 'clicks' into place.

Check the seat unit is able to rotate fully.

Removing the seat unit

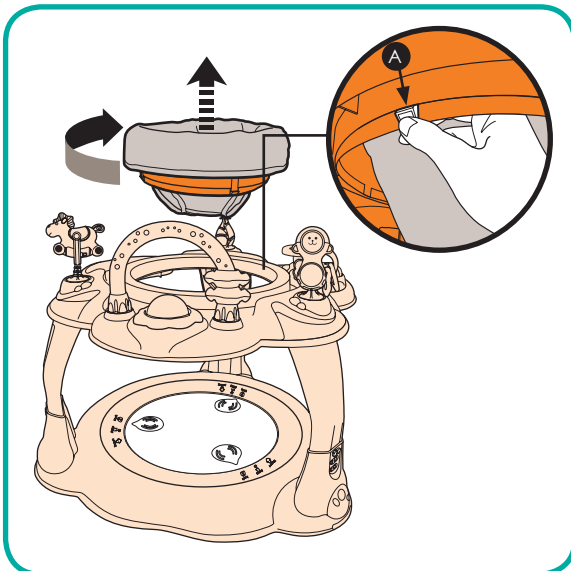

1. Press the clips (A) on the underside of the seat unit whilst lifting and rotating the seat unit.

ATTENTION: Children can play inside the activity centre ONLY when the footplate has been fully installed into the base.

Height adjustment

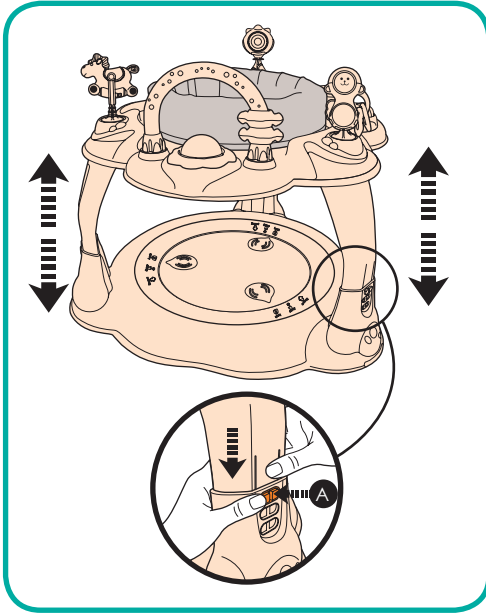

1. Press in the button on each leg and raise or lower the leg until it clicks into place.

Note: Ensure all legs are set at the same height before using.

WARNING: DO NOT adjust the height whilst a child is seated in the activity centre.

WARNING: If your child is too small or too big to stand with their legs straight and feet flat on the foot plate, then this product is no longer suitable for your child and your child should not use it. If your child is not standing correctly then this could lead to posture problems/discomfort or create a potential tipping hazard.

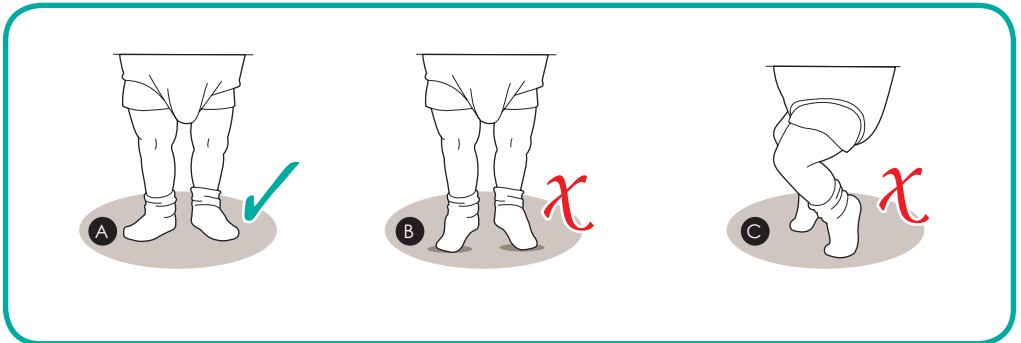

- A. Tray at correct height.
- B. Tray too high (child is on tip-toes).
- C. Tray too low (child has bent knees).

Removing the footplate

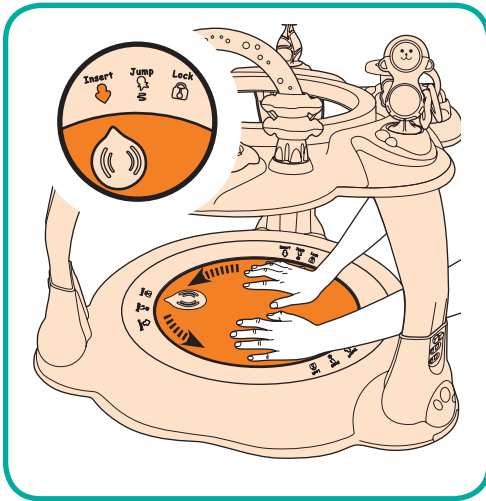

1. Press down on the footplate and rotate it to the left. Allow the footplate to spring up and then press down on one edge of the footplate to force the opposite edge up and remove the footplate.

Play table assembly

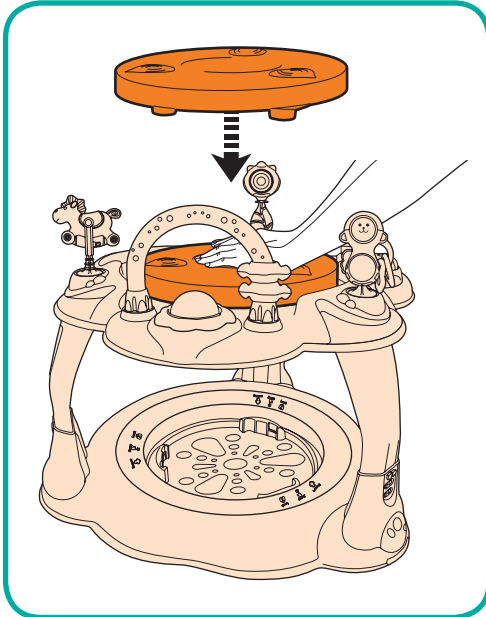

1. Remove the seat unit (see page 11), remove the footplate (see page 13). Insert the footplate into the seat tray, pressing it down until it 'clicks' into place.

Check the play table/footplate is properly installed and is able to rotate fully.

Play table disassembly

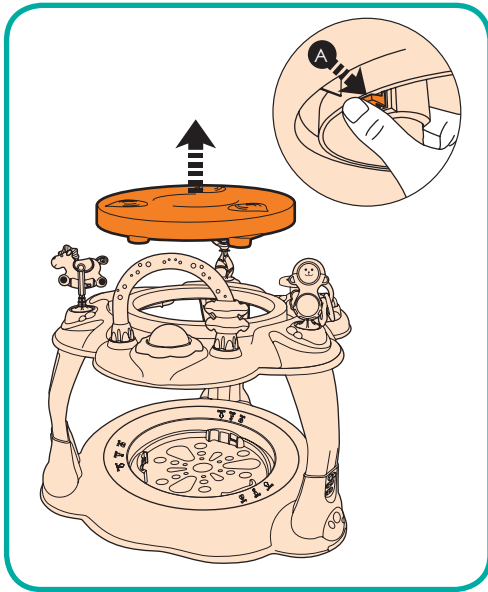

1. Press in the three buttons (A) on the underside of the play table/footplate and remove.

Care and maintenance

- To prolong the life of your nursery product keep it clean and do not leave it in direct sunlight for extended periods of time.
- Plastic parts can be wiped clean with a damp cloth and mild soap then allowed to air dry.
- DO NOT immerse plastic parts in water.
- Removable fabric covers and trims may be cleaned using a damp sponge with soap or mild detergent. Allow it to dry completely before folding or storing it away.
- Do not dry clean, or use bleach.
- In some climates the covers and trims may be affected by mould and mildew. To help prevent this occurring, do not fold or store the product if it is damp or wet. Always store the product in a well ventilated area.
- Always check parts regularly for tightness of screws, nuts and other fasteners - tighten if required. To maintain the safety of your nursery product, seek prompt repairs for bent, torn, worn or broken parts.
- Do not use the product if any components are broken or missing
- Regularly clean parts that have been mouthed by your child.



www.mychild.co.uk

Customerservice@kooltrade.co.uk
Imported by Kooltrade Ltd. M34 3QA
Tel: 0161 335 2508